

BSLIGHT

Catálogo Iluminación

NOVEDADES

Tiras LEDs

Perfiles

Control

Proyectores de piscinas

NUEVOS PRODUCTOS



Lighting Catalogue

“Tenemos un compromiso global con el ahorro energético”



Desde un inicio todos nuestros productos se diseñan y producen con el fin de poder ofrecer una mejora en el aspecto del ahorro energético y sostenibilidad del medio ambiente. Nuestro compromiso con el medio ambiente va más allá y todos los procesos internos de nuestra empresa están orientados a este objetivo.

BSV fue creada en 1984 con el fin de ofrecer soluciones electrónicas a todas las empresas fabricantes de la zona. Rápidamente nuestra empresa fue ocupando un lugar en la fabricación de equipos electrónicos para diferentes sectores. La experiencia en el canal industrial llevó a BSV a especializarse en el diseño y fabricación de sus propios productos, siempre enfocados al sector de la piscina e iluminación.

En la actualidad, BSV cree firmemente en la fabricación local, dando un valor muy importante a la marca MADE IN BARCELONA y MADE IN SPAIN, que reflejan y transmiten fielmente nuestra experiencia y saber hacer.

En este catálogo hemos usado diferentes papeles FSC, reciclados y libres de cloro. Se ha impreso en CMYK para poder presentar nuestros productos fielmente y reduciendo sensiblemente la cantidad de tinta utilizada. El tamaño del papel es el estándar para generar la menor merma de papel posible y usando esta merma para realizar los marcadores de las páginas.

“We have a global commitment with energetic savings”



All our products are designed and produced with the goal to save energy and improve our relationship with the environment. Our commitment with the environment goes beyond and all our processes are thought to reach this target.

BSV was established in 1984 to provide electronic solutions to the manufacturers in the area. Quickly our company was occupying a place in the design and production of electronic equipment for different sectors. The experience in the industrial field led to BSV specializing in the design and production of its own products, always focused on the swimming pool and lighting sector.

Currently, BSV strongly believes in local manufacturing, giving a very important value to the brand MADE IN BARCELONA and MADE IN SPAIN, that reflect and faithfully transmit our experience and know-how.

In this catalogue, we have used different FSC papers, recycled and chlorine-free. It has printed in CMYK to be able to present our products faithfully and substantially reducing the amount of ink used. The paper size is the standard for generating less waste of paper and using this waste to make page markers.

TIRAS Y MÓDULOS / STRIPS AND MODULES

- | | | | |
|----|--|----|--|
| 8 | Tiras flexibles monocolor 60 LEDS/m 3528 IP33
Single-color flexible strips 60 LEDS/m 3528 IP33 | 33 | Tiras flexibles monocolor 60 LEDS/m 5050 IP33 en rollo de 50 m
Single-color flexible strips 60 LEDS/m 5050 IP33 rolls of 50m |
| 9 | Tiras flexibles monocolor 60 LEDS/m 3528 IP66
Single-color flexible strips 60 LEDS/m 3528 IP66 | 34 | Tiras flexibles monocolor 60 LEDS/m 5050 IP66 en rollo de 50 m
Single-color flexible strips 60 LEDS/m 5050 IP66 rolls of 50m |
| 10 | Tiras flexibles monocolor 60 LEDS/m 3528 IP68
Single-color flexible strips 60 LEDS/m 3528 IP68 | 35 | Tiras flexibles monocolor y RGB 60 LEDS/m IP68 a 230 VAC
Single-color and RGB flexible strips 60 LEDS/m IP68 for 230 VAC |
| 11 | Tiras flexibles monocolor 60 LEDS/m 335 IP33
asimétrica 90° / Single-color flexible strips
60 LEDS/m 335 IP33 asymmetric 90° | 36 | Tiras flexibles Flexneon / Neonflex Flexible strips |
| 12 | Tiras flexibles monocolor 60 LEDS/m 335 IP66
asimétrica 90° / Single-color flexible strips
60 LEDS/m 335 IP66 asymmetric 90° | 37 | Tiras flexibles 32 LEDS/m 5050 serie Smart
Serie Smart flexible strips 32 LEDS/m 5050 |
| 13 | Tiras flexibles monocolor 60 LEDS/m 2835 IP33 3D
Single-color flexible strips 60 LEDS/m 3825 IP33 3D | 38 | Tiras flexibles DUAL 60 LEDS/m 5050 Blanco Frío + Blanco
Cálido / Dual flexible strips 60 LEDS/m 5050 Cold White +
Warm White |
| 14 | Tiras flexibles monocolor 120 LEDS/m 3528 IP33
Single-color flexible strips 120 LEDS/m 3528 IP33 | 39 | Conectores y empalmes sin soldadura / Connectors and
junctions without welding
Termorretráctil con silicona / Heat shrinking tube with
silicone |
| 15 | Tiras flexibles monocolor 120 LEDS/m 3528 IP66
Single-color flexible strips 120 LEDS/m 3528 IP66 | 40 | Módulo 2 LEDS / 2 LEDS modules |
| 16 | Tiras flexibles monocolor 120 LEDS/m 3528 IP68
Single-color flexible strips 120 LEDS/m 3528 IP68 | 41 | Módulo 4 LEDS / 4 LEDS modules |
| 17 | Tiras flexibles monocolor 240 LEDS/m 3528 IP33
Single-color flexible strips 240 LEDS/m 3528 IP33 | 42 | Módulo 3 LEDS RGB / 3 LEDS modules RGB |
| 18 | Tiras flexibles monocolor 240 LEDS/m 3528 IP66
Single-color flexible strips 240 LEDS/m 3528 IP66 | | |
| 19 | Tiras flexibles monocolor 240 LEDS/m 3528 IP68
Single-color flexible strips 240 LEDS/m 3528 IP68 | | |
| 20 | Tiras flexibles monocolor o RGB 30 LEDS/m 5050 IP33
RGB or Single-color flexible strips 30 LEDS/m 5050 IP33 | | |
| 21 | Tiras flexibles monocolor o RGB 30 LEDS/m 5050 IP66
RGB or Single-color flexible strips 30 LEDS/m 5050 IP66 | | |
| 22 | Tiras flexibles monocolor o RGB 30 LEDS/m 5050 IP68
RGB or Single-color flexible strips 30 LEDS/m 5050 IP68 | | |
| 23 | Tiras flexibles monocolor o RGB 60 LEDS/m 5050 IP33
RGB or Single-color flexible strips 60 LEDS/m 5050 IP33 | | |
| 24 | Tiras flexibles monocolor o RGB 60 LEDS/m 5050 IP66
RGB or Single-color flexible strips 60 LEDS/m 5050 IP66 | | |
| 25 | Tiras flexibles monocolor o RGB 60 LEDS/m 5050 IP68
RGB or Single-color flexible strips 60 LEDS/m 5050 IP68 | | |
| 26 | Tiras flexibles monocolor 60 LEDS/m 5630 IP33 HP
Single-color flexible strips 60 LEDS/m 5630 IP33 HP | | |
| 27 | Tiras flexibles monocolor 96 LEDS/m 2835 SAP
Single-color flexible strips 96 LEDS/m 2835 SAP | | |
| 28 | Tiras flexibles monocolor 120 LEDS/m 2835 IP33 RA95
Single-color flexible strips 120 LEDS/m 2835 IP33 RA95 | | |
| 29 | Tiras flexibles monocolor 120 LEDS/m 2835 IP66 RA95
Single-color flexible strips 120 LEDS/m 2835 IP66 RA95 | | |
| 30 | Tiras flexibles monocolor 182 LEDS/m 2835 HP IP33 RA95
Single-color flexible strips 182 LEDS/m HP 2835 IP33 RA95 | | |
| 31 | Tiras flexibles RGBW 60 LEDS/m 5050 IP33
RGBW Flexible strips 60 LEDS/m 5050 IP33 | | |
| 32 | Tiras flexibles RGBW 60 LEDS/m 5050 IP66
RGBW Flexible strips 60 LEDS/m 5050 IP66 | | |

PERFILES Y ACCESORIOS / PROFILES AND ACCESSORIES

- | | |
|----|---|
| 46 | Perfil aluminio redondo / Round aluminum profile
Perfil aluminio esquinera / Corner aluminum profile |
| 47 | Perfil aluminio estanco / Waterproof aluminum profile
Perfil aluminio con canal / Aluminum profile with guide |
| 48 | Perfil aluminio esquinera cuadrados / Square corner
aluminum profile
Perfil aluminio esquinera redondo / Round corner aluminum
profile |
| 49 | Perfil aluminio empotrar mini / Mini recessed aluminum profile
Perfil aluminio superficie mini / Mini surface aluminum profile |
| 50 | Perfil aluminio empotrar estándar / Standard recessed
aluminum profile
Perfil aluminio superficie estándar / Standard aluminum profile |
| 51 | Perfil aluminio 16mm con óptica / 16mm aluminum profile with
optic diffuser
Perfil aluminio 16mm redondo / 16mm round aluminum profile |
| 52 | Perfil aluminio 16mm cuadrado / 16mm square aluminum profile
Perfil aluminio ELH / ELH aluminum profile |
| 53 | Perfil aluminio empotrar 31mm / Recessed aluminum profile 31mm
Perfil aluminio superficie 31mm / Surface aluminum 31mm |
| 54 | Perfil aluminio superficie alta densidad 12,2mm / Surface high
density aluminum profile 12,2mm
Perfil aluminio superficie alta densidad 20,2mm / Surface high
density aluminum profile 20,2mm |
| 55 | Perfil aluminio superficie alta densidad 43,3mm bajo / Surface
high density aluminum profile 43,3mm low
Perfil aluminio superficie alta densidad 43,3mm estándar
Surface high density aluminum profile 43,3mm standard |
| 56 | Perfil aluminio empotrar alta densidad 43,3mm / Recessed
high density aluminum profile 43,3mm
Perfil aluminio para peldaños / Steps aluminum profile |

ÍNDICE

- 57 Perfil aluminio esquinero 30mm / Corner aluminum profile 30mm
- Perfil aluminio esquinero 55mm / Corner aluminum profile 55mm
- 58 Perfil aluminio forma Y / Y aluminum profile
- Perfil aluminio para zócalos / Socle aluminum profile
- 59 Sensor de contacto para perfiles / Contact sensor for profiles
- Sensor de proximidad para perfiles / Proximity sensors for profiles
- 60 Kit de suspensión de perfiles / Suspension kit to profile
- Grapa fijación 180° / Rotary clip 180°

FUENTES Y CONTROLADORES DRIVERS AND CONTROLLERS

- 64 Fuentes de corriente constante / Constant current drivers
- 65 Fuentes de tensión constante para interior / Indoor constant tension drivers
- 66 Fuentes de tensión constante para exterior / Outdoor constant tension drivers
- 67 Controladores RGB / RGB Controllers
- 68 Controlador RGB serie M / RGB Controller serie M
- 69 Controlador RGBW serie V / RGBW Controller serie V
- 70 Control RGBW multizona / Touch RGBW multizone
- 71 Control RGB multizona / Touch RGB multizone
- 72 Panel táctil mural RGB / Touch RGB panel mural
- 73 Panel táctil mural RGBW RF+DMX / Touch panel mural RGBW RF+DMX
- 74 Controlador wifi con aplicación IOS y Android
- Wifi controller for IOS and Android
- 75 Reguladores monocolor PWM / Single-color PWM regulators
- 76 Control monocolor multizona / Touch single-color multizone
- 77 Panel táctil mural monocolor / Touch single color panel mural
- 78 Panel táctil mural monocolor RF+DMX / Touch panel mural single-color +DMX
- 79 Amplificador RGB / RGB amplifier
- 80 Regulador por Triac / Triac dimmer
- 81 Regulador por pulsador / Push-button control
- 82 Reguladores 0-10V / 0-10V dimmers
- 83 Reguladores Dali / Dali dimmers
- 84 Decodificador DMX / DMX decoder
- 85 Transmisor DMX inalámbrico / DMX wireless transmitter
- 86 Interface USB-DMX / USB-DMX interface
- 87 Interface USB-DMX panel táctil / Touch panel USB-DMX interface
- 88 Sensores de presencia y contacto / Presence and contact sensors

ILUMINACIÓN EXTERIOR / OUTDOOR LIGHTING

- 92 Empotrable de suelo 55mm / Recessed inground 55mm
- 93 Empotrable de suelo 116mm / Recessed inground 116mm
- 94 Empotrable de suelo 173mm / Recessed inground 173mm
- 95 Piquetas de jardín / Garden spikes
- 96 Proyectores de jardín / Garden spotlight
- 97 Proyectores alta potencia / High power outdoor spotlight
- 98 Bañador de pared / Wall washer
- 99 Empotrable sumergible 67mm / Waterproof recessed 67mm
- 100 Empotrable sumergible 135mm / Waterproof recessed 135mm
- 101 Empotrable sumergible 180mm / Waterproof recessed 180mm
- 102 Empotrable sumergible rectangular / Waterproof recessed rectangular
- 103 Proyectores sumergibles / Waterproof spotlight
- 104 Mini proyectores para piscina / Mini spotlight for swimming pool
- 105 Bombilla PAR56 / PAR56 bulb
- 106 Proyectores planos para piscina / Swimming pool flat spotlights
- 107 Controlador RGB para PAR56 y proyectores / RGB controller for PAR56 and projector

SEÑALIZACIÓN INDUSTRIAL INDUSTRIAL SIGNALLING

- 110 Bombillas BA9s multiled / BA9s multiled bulbs
- 111 Piloto 5mm / 5mm pilot
- 112 Pilotos 22mm multiled / Multiled 22mm pilots
- 113 Baliza multiled 22mm / Multiled beacon 22mm

ILUMINACIÓN INDUSTRIAL / INDUSTRIAL LIGHTING

- 116 Campanas industriales hasta 100W
- Led high bay light until 100W
- 117 Campanas industriales hasta 200W
- Led high bay light until 200W
- 118 Proyectores hasta 50W / Flood light until 50W
- 119 Proyectores hasta 200W / Flood light until 200W
- 120 Luminaria urbana 56W / Street light 56W
- 121 Luminaria urbana 98W / Street light 98W
- 122 Luminaria urbana 126W / Street light 126W



TIRAS Y MÓDULOS

01

STRIPS AND MODULES



TIRAS FLEXIBLES MONOCOLOR 60 LEDS/m 3528 IP33

SINGLE-COLOR FLEXIBLE STRIPS

60 LEDS/m 3528 IP33



Rollo de tira flexible de 5 mts monocolor 60 LEDS/m 3528. Se puede cortar cada 3 LEDS (50mm). Se suministra con adhesivo 3M de doble cara. Protección IP33.

5 mts Flexible strip roll single-color with 60 LEDS/m 3528. Can be cut every 3 LEDS (50mm). Provided with 3M double side adhesive. IP33 protection.

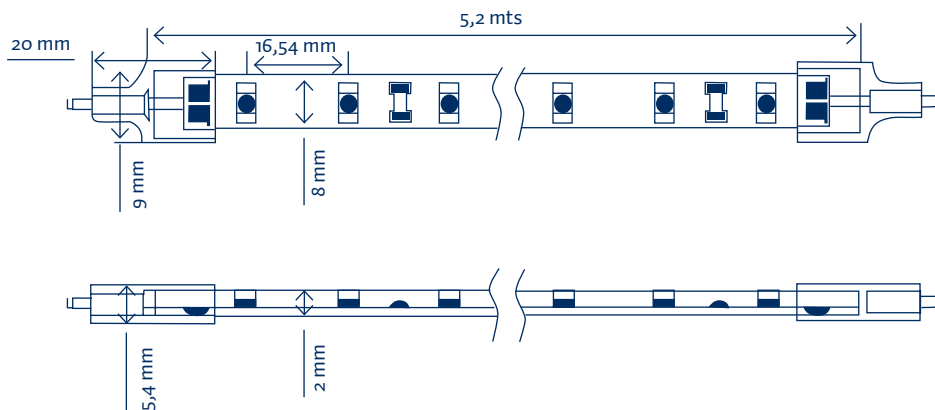

	COLOR COLOR	PROTECCIÓN PROTECTION	ALIMENTACIÓN POWER SUPPLY	TIPO LED LED TYPE	CANT. mts Qty OF LED	FLUJO LUM. LUM. FLOW	CONSUMO CONSUME
TF5R	■	IP 33	12V DC	3528	60 LEDS/ m	120lm/m	4,8W/ m
TF5AB	■	IP 33	12V DC	3528	60 LEDS/ m	120lm/m	4,8W/ m
TF5AZ	■	IP 33	12V DC	3528	60 LEDS/ m	150lm/m	4,8W/ m
TF5V	■	IP 33	12V DC	3528	60 LEDS/ m	240lm/m	4,8W/ m
TF5BF	6000 K	IP 33	12V DC	3528	60 LEDS/ m	390lm/m	4,8W/ m
TF5BD	4000 K	IP 33	12V DC	3528	60 LEDS/ m	380lm/m	4,8W/ m
TF5BC	3000 K	IP 33	12V DC	3528	60 LEDS/ m	360lm/m	4,8W/ m

Fuente de alimentación recomendada para un rollo de 5 m LRS3512 (12V 35W) / Recommended power supply for a 5 m roll: LRS3512 (12V 35W)



TIRAS FLEXIBLES MONOCOLOR 60 LEDS/m 3528 IP66

SINGLE-COLOR FLEXIBLE STRIPS

60 LEDS/m 3528 IP66



Rollo de tira flexible de 5 mts monocolor 60 LEDS/m 3528. Se puede cortar cada 3 LEDS (50 mm). Se suministra con adhesivo 3M de doble cara. Protección IP66.

5 mts Flexible strip roll single-color with 60 LEDS/m 3528. Can be cut every 3 LEDS (50 mm). Provided with 3M double side adhesive. IP66 protection.

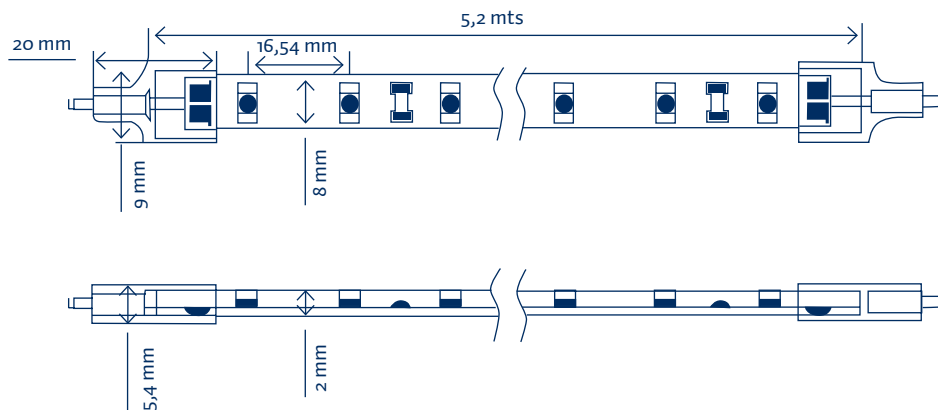

	COLOR COLOR	PROTECCIÓN PROTECTION	ALIMENTACIÓN POWER SUPPLY	TIPO LED LED TYPE	CANT. mts Qty OF LED	FLUJO LUM. LUM. FLOW	CONSUMO CONSUME
TF5RIP66	█	IP 66	12V DC	3528	60 LEDS/ m	120lm/m	4,8W/m
TF5ABIP66	█	IP 66	12V DC	3528	60 LEDS/ m	120lm/m	4,8W/m
TF5AZIP66	█	IP 66	12V DC	3528	60 LEDS/ m	150lm/m	4,8W/m
TF5VIP66	█	IP 66	12V DC	3528	60 LEDS/ m	240lm/m	4,8W/m
TF5BFIP66	6000 K	IP 66	12V DC	3528	60 LEDS/ m	390lm/m	4,8W/m
TF5BCIP66	4000 K	IP 66	12V DC	3528	60 LEDS/ m	380lm/m	4,8W/m
TF5BCIP66	3000 K	IP 66	12V DC	3528	60 LEDS/ m	360lm/m	4,8W/m

Fuente de alimentación recomendada para un rollo de 5 m LRS3512 (12V 35W) / Recommended power supply for a 5 m roll: LRS3512 (12V 35W)



TIRAS FLEXIBLES MONOCOLOR 60 LEDS/m

3528 IP68

SINGLE-COLOR FLEXIBLE STRIPS

60 LEDS/m 3528 IP68



Rollo de tira flexible de 5 mts monocolor 60 LEDS/m 3528. Se puede cortar cada 3 LEDS (50 mm). Se suministra con adhesivo 3M de doble cara. Protección IP68.

5 mts Flexible strip roll single-color with 60 LEDS/m 3528. Can be cut every 3 LEDS (50 mm). Provided with 3M double side adhesive. IP68 protection.

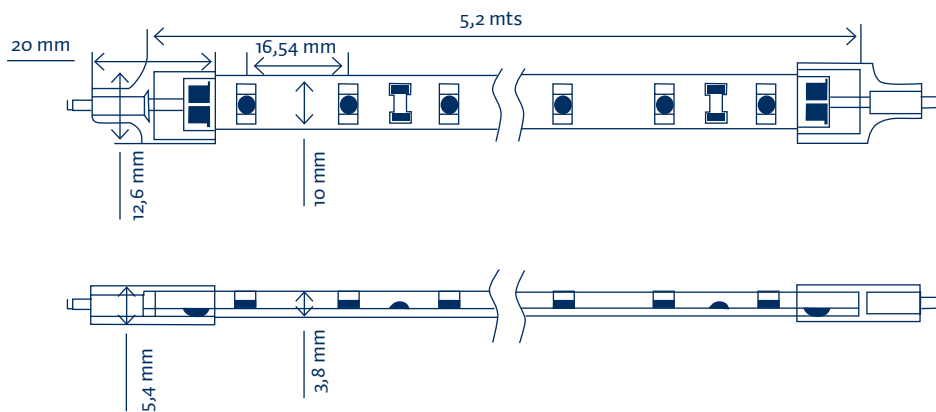

	COLOR COLOR	PROTECCIÓN PROTECTION	ALIMENTACIÓN POWER SUPPLY	TIPO LED LED TYPE	CANT. mts Qty OF LED	FLUJO LUM. LUM. FLOW	CONSUMO CONSUME
TF5RIP68	█	IP 68	12V DC	3528	60 LEDS/ m	120lm/m	4,8W/m
TF5ABIP68	█	IP 68	12V DC	3528	60 LEDS/ m	120lm/m	4,8W/m
TF5AZIP68	█	IP 68	12V DC	3528	60 LEDS/ m	150lm/m	4,8W/m
TF5VIP68	█	IP 68	12V DC	3528	60 LEDS/ m	240lm/m	4,8W/m
TF5BFIP68	6000 K	IP 68	12V DC	3528	60 LEDS/ m	390lm/m	4,8W/m
TF5BCIP68	3000 K	IP 68	12V DC	3528	60 LEDS/ m	360lm/m	4,8W/m

Fuente de alimentación recomendada para un rollo de 5 mts LPV3512 (12V 35W) / Recommended power supply for a 5 mts roll: LPV3512 (12V 35W)



TIRAS FLEXIBLES MONOCOLOR 60 LEDS/m 335 IP33 ASIMÉTRICA 90° SINGLE-COLOR FLEXIBLE STRIPS 60 LEDS/m 335 IP33 ASYMETRIC 90°



Rollo de tira flexible de 5 mts monocolor 60 LEDS/m 335. Se puede cortar cada 3 LEDS (50 mm). Se suministra con adhesivo 3M de doble cara. Protección IP33. LEDS inclinados 90° para generar un haz de luz asimétrico.

5 mts Flexible strip roll single-color with 60 LEDS/m 335. Can be cut every 3 LEDS (50 mm). Provided with 3M double side adhesive. IP33 protection. Asymetric light 90°.

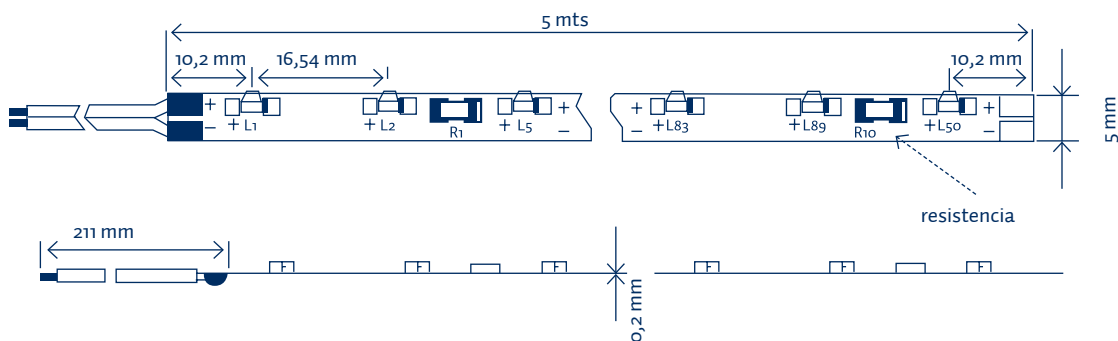

	COLOR COLOR	PROTECCIÓN PROTECTION	ALIMENTACIÓN POWER SUPPLY	TIPO LED LED TYPE	CANT. mts Qty OF LED	FLUJO LUM. LUM. FLOW	CONSUMO CONSUME
TF5R90	█	IP 33	12V DC	335	60 LEDS/ m	120lm/m	4,8W/m
TF5AB90	█	IP 33	12V DC	335	60 LEDS/ m	120lm/m	4,8W/m
TF5AZ90	█	IP 33	12V DC	335	60 LEDS/ m	150lm/m	4,8W/m
TF5V90	█	IP 33	12V DC	335	60 LEDS/ m	240lm/m	4,8W/m
TF5BF90	6000 K	IP 33	12V DC	335	60 LEDS/ m	390lm/m	4,8W/m
TF5BC90	3000 K	IP 33	12V DC	335	60 LEDS/ m	360lm/m	4,8W/m1

Fuente de alimentación recomendada para un rollo de 5 mts LRS3512 (12V 35W) / Recommended power supply for a 5 mts roll: LRS3512 (12V 35W)

12
13



TIRAS FLEXIBLES MONOCOLOR 60 LEDS/m 335 IP66 ASIMÉTRICA 90°

SINGLE-COLOR FLEXIBLE STRIPS 60 LEDS/m 335 IP66 ASYMETRIC 90°



Rollo de tira flexible de 5 mts monocolor 60 LEDS/m 335. Se puede cortar cada 3 LEDS (50mm). Se suministra con adhesivo 3M de doble cara. Protección IP66. LEDS inclinados 90° para generar un haz de luz asimétrico.

5 mts flexible strip roll single-color with 60 LEDS/m 335. Can be cut every 3 LEDS (50mm). Provided with 3M double side adhesive. IP66 protection. Asymetric light 90°.

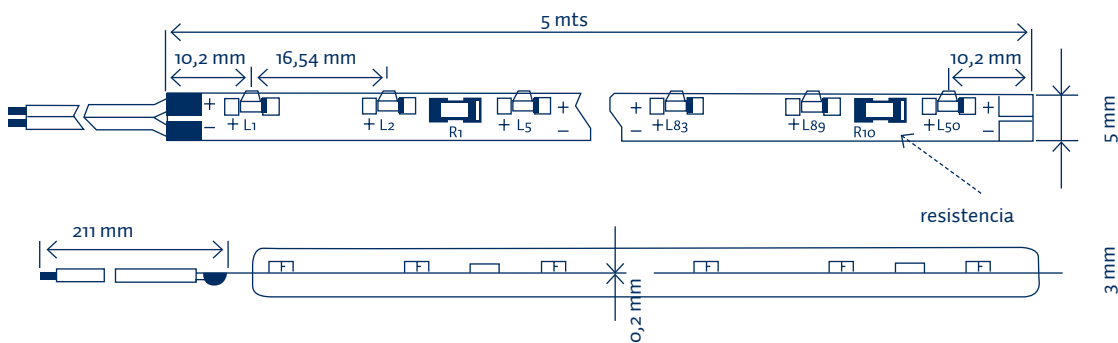

	COLOR COLOR	PROTECCIÓN PROTECTION	ALIMENTACIÓN POWER SUPPLY	TIPO LED LED TYPE	CANT. mts Qty OF LED	FLUJO LUM. LUM. FLOW	CONSUMO CONSUME
TF5R90-IP66		IP 66	12V DC	335	60 LEDS/ m	120lm/m	4,8W/m
TF5AB90-IP66		IP 66	12V DC	335	60 LEDS/ m	120lm/m	4,8W/m
TF5AZ90-IP66		IP 66	12V DC	335	60 LEDS/ m	150lm/m	4,8W/m
TF5V90-IP66		IP 66	12V DC	335	60 LEDS/ m	240lm/m	4,8W/m
TF5BF90-IP66	6000 K	IP 66	12V DC	335	60 LEDS/ m	390lm/m	4,8W/m
TF5BC90-IP66	3000 K	IP 66	12V DC	335	60 LEDS/ m	360lm/m	4,8W/m

Fuente de alimentación recomendada para un rollo de 5 mts LRS3512 (12V 35W) / Recommended power supply for a 5 mts roll: LRS3512 (12V 35W)

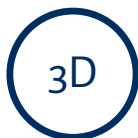

TIRAS FLEXIBLES MONOCOLOR
60 LEDS/m 2835 IP33 3D
SINGLE-COLOR FLEXIBLE STRIPS
60 LEDS/m 2835 IP33 3D



Rollo de tira flexible de 5mts monocolor 60 LEDS/m 2835 en formato 3D para poder instalar en cualquier dirección. Se puede cortar cada 3 leds (50mm). Se suministra con adhesivo 3M de doble cara. Protección IP33.

5mt Flexible strip roll single-color with 60 LEDS/m 2835 in format 3D. Can be cut every 3 LEDs (50mm). Provided with 3M double side adhesive. IP33 protection.

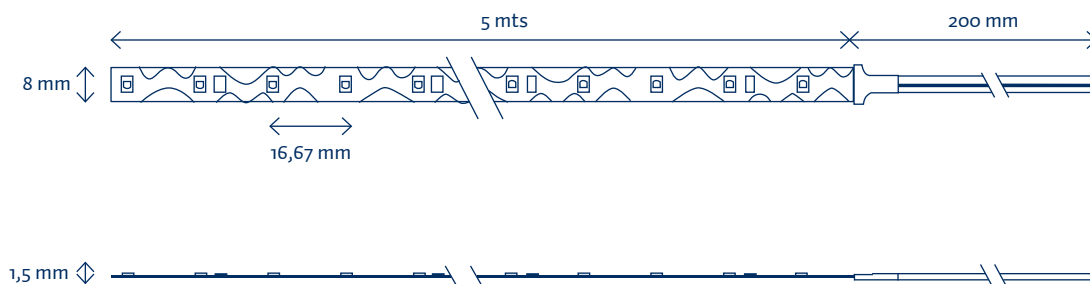

	COLOR COLOR	PROTECCIÓN PROTECTION	ALIMENTACIÓN POWER SUPPLY	TIPO LED LED TYPE	CANT. mts Qty OF LED	FLUJO LUM. LUM. FLOW	CONSUMO CONSUME
TF5BF-3D	6000 K	IP33	12V DC	2835	60 LEDS/m	596lm/m	6.4W/m
TF5BD-3D	4000 K	IP33	12V DC	2835	60 LEDS/m	572lm/m	6.4W/m
TF5BC-3D	3000 K	IP33	12V DC	2835	60 LEDS/m	496lm/m	6.4W/m

Fuente de alimentación recomendada para un rollo de 5mts LRS5012 / Recommended power supply for a 5mt roll: LRS5012



TIRAS FLEXIBLES MONOCOLOR 120 LEDS/m

3528 IP33

SINGLE-COLOR FLEXIBLE STRIPS

120 LEDS/m 3528 IP33



Rollo de tira flexible de 5 mts monocolor 120 LEDS/m. Se puede cortar cada 6 LEDS (50mm). Se suministra con adhesivo 3M de doble cara. Protección IP33.

5 mts Flexible strip roll single-color with 120 LEDS/m. Can be cut every 6 LEDS (50mm). Provided with 3M double side adhesive. IP33 protection.

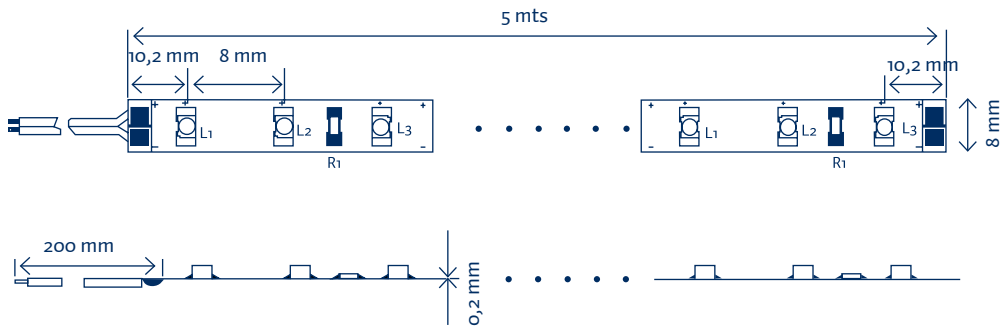

	COLOR COLOR	PROTECCIÓN PROTECTION	ALIMENTACIÓN POWER SUPPLY	TIPO LED LED TYPE	CANT. mts Qty OF LED	FLUJO LUM. LUM. FLOW	CONSUMO CONSUME
TF5R-600		IP 33	24V DC	3528	120 LEDS/ m	240lm/m	9,6W/ m
TF5AB-600		IP 33	24V DC	3528	120 LEDS/ m	240lm/m	9,6W/ m
TF5AZ-600		IP 33	24V DC	3528	120 LEDS/ m	300lm/m	9,6W/ m
TF5V-600		IP 33	24V DC	3528	120 LEDS/ m	480lm/m	9,6W/ m
TF5BF-600	6000 K	IP 33	24V DC	3528	120 LEDS/ m	780lm/m	9,6W/ m
TF5BC-600	3000 K	IP 33	24V DC	3528	120 LEDS/ m	720lm/m	9,6W/ m

Fuente de alimentación recomendada para un rollo de 5 mts LRS7524 (24V 75W) / Recommended power supply for a 5 mts roll: LRS7524 (24V 75W)



TIRAS FLEXIBLES MONOCOLOR 120 LEDS/m

3528 IP66

SINGLE-COLOR FLEXIBLE STRIPS

120 LEDS/m 3528 IP66



Rollo de tira flexible de 5 mts monocolor 120 LEDS/m. Se puede cortar cada 6 LEDS (50mm). Se suministra con adhesivo 3M de doble cara. Protección IP66.

5 mts Flexible strip roll single-color with 120 LEDS/m. Can be cut every 6 LEDS (50mm). Provided with 3M double side adhesive. IP66 protection.

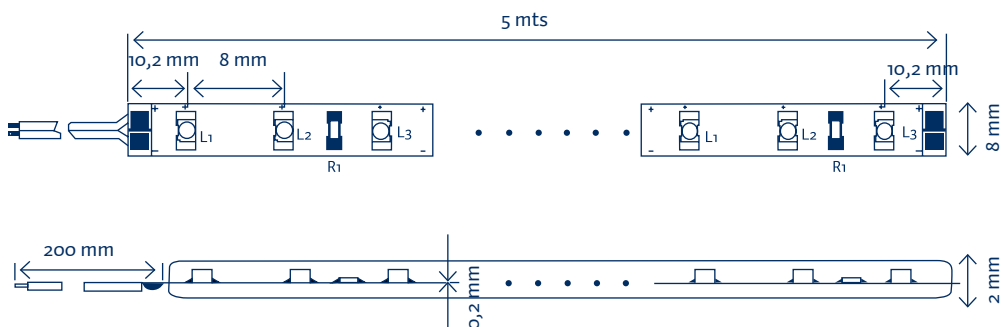

	COLOR COLOR	PROTECCIÓN PROTECTION	ALIMENTACIÓN POWER SUPPLY	TIPO LED LED TYPE	CANT. mts Qty OF LED	FLUJO LUM. LUM. FLOW	CONSUMO CONSUME
TF5R-600-IP66	■	IP 66	24V DC	3528	120 LEDS/ m	240lm/m	9,6W/ m
TF5AB-600-IP66	■	IP 66	24V DC	3528	120 LEDS/ m	240lm/m	9,6W/ m
TF5AZ-600-IP66	■	IP 66	24V DC	3528	120 LEDS/ m	300lm/m	9,6W/ m
TF5V-600-IP66	■	IP 66	24V DC	3528	120 LEDS/ m	480lm/m	9,6W/ m
TF5BF-600-IP66	6000 K	IP 66	24V DC	3528	120 LEDS/ m	780lm/m	9,6W/ m
TF5BD-600-IP66	4000 K	IP 66	24V DC	3528	120 LEDS/ m	760lm/m	9,6W/ m
TF5BC-600-IP66	3000 K	IP 66	24V DC	3528	120 LEDS/ m	720lm/m	9,6W/ m

Fuente de alimentación recomendada para un rollo de 5 mts LRS7524 (24V 75W) / Recommended power supply for a 5 mts roll: LRS7524 (24V 75W)



TIRAS FLEXIBLES MONOCOLOR 120 LEDS/m

3528 IP68

SINGLE-COLOR FLEXIBLE STRIPS

120 LEDS/m 3528 IP68



Rollo de tira flexible de 5 mts monocolor 120 LEDS/m 3528. Se puede cortar cada 6 LEDS (50mm). Se suministra con adhesivo 3M de doble cara. Protección IP68.

5 mts Flexible strip roll single-color with 120 LEDS/m 3528. Can be cut every 6 LEDS (50mm). Provided with 3M double side adhesive. IP68 protection.

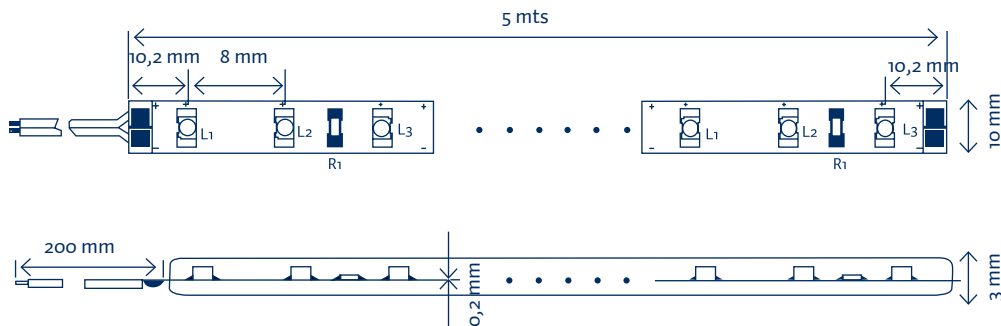

	COLOR COLOR	PROTECCIÓN PROTECTION	ALIMENTACIÓN POWER SUPPLY	TIPO LED LED TYPE	CANT. mts Qty OF LED	FLUJO LUM. LUM. FLOW	CONSUMO CONSUME
TF5R-600-IP68		IP68	24V DC	3528	120 LEDS/ m	240lm/m	9,6W/ m
TF5AB-600-IP68		IP68	24V DC	3528	120 LEDS/ m	240lm/m	9,6W/ m
TF5AZ-600-IP68		IP68	24V DC	3528	120 LEDS/ m	300lm/m	9,6W/ m
TF5V-600-IP68		IP68	24V DC	3528	120 LEDS/ m	480lm/m	9,6W/ m
TF5BF-600-IP68	6000 K	IP68	24V DC	3528	120 LEDS/ m	780lm/m	9,6W/ m
TF5BC-600-IP68	3000 K	IP68	24V DC	3528	120 LEDS/ m	720lm/m	9,6W/ m

Fuente de alimentación recomendada para un rollo de 5 mts LPV6024 / Recommended power supply for a 5 mts roll: LPV6024



TIRAS FLEXIBLES MONOCOLOR 240 LEDS/m 3528 IP33

SINGLE-COLOR FLEXIBLE STRIPS

240 LEDS/m 3528 IP33



Rollo de tira flexible de 5 mts monocolor 240 LEDS/m 3528. Se puede cortar cada 12 LEDS (50mm). Se suministra con adhesivo 3M de doble cara. Protección IP33.

5 mts Flexible strip roll single-color with 240 LEDS/m 3528. Can be cut every 12 LEDS (50mm). Provided with 3M double side adhesive. IP33 protection.

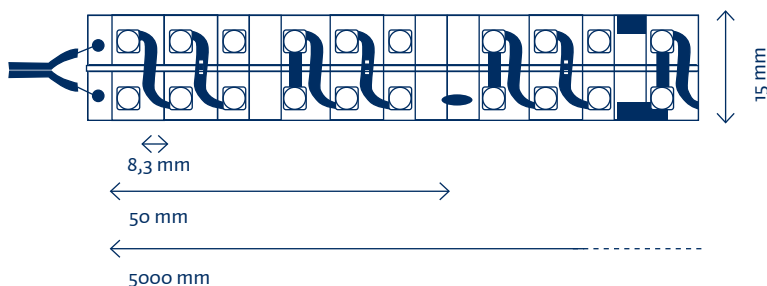

	COLOR COLOR	PROTECCIÓN PROTECTION	ALIMENTACIÓN POWER SUPPLY	TIPO LED LED TYPE	CANT. mts Qty OF LED	FLUJO LUM. LUM. FLOW	CONSUMO CONSUME
TF5R-1200		IP 33	24V DC	3528	240 LEDS/ m	480lm/m	19,2W/ m
TF5AB-1200		IP 33	24V DC	3528	240 LEDS/ m	480lm/m	19,2W/ m
TF5AZ-1200		IP 33	24V DC	3528	240 LEDS/ m	600lm/m	19,2W/ m
TF5V-1200		IP 33	24V DC	3528	240 LEDS/ m	560lm/m	19,2W/ m
TF5BF-1200	6000 K	IP 33	24V DC	3528	240 LEDS/ m	1560lm/m	19,2W/ m
TF5BC-1200	3000 K	IP 33	24V DC	3528	240 LEDS/ m	1440lm/m	19,2W/ m

Fuente de alimentación recomendada para un rollo de 5 mts LRS15024./ Recommended power supply for a 5 mts roll: LRS15024.



TIRAS FLEXIBLES MONOCOLOR 240 LEDS/m

3528 IP66

SINGLE-COLOR FLEXIBLE STRIPS

240 LEDS/m 3528 IP66



Rollo de tira flexible de 5 mts monocolor 240 LEDS/m 3528. Se puede cortar cada 12 LEDS (50mm). Se suministra con adhesivo 3M de doble cara. Protección IP66.

5 mts Flexible strip roll single-color with 240 LEDS/m 3528. Can be cut every 12 LEDS (50mm). Provided with 3M double side adhesive. IP66 protection.

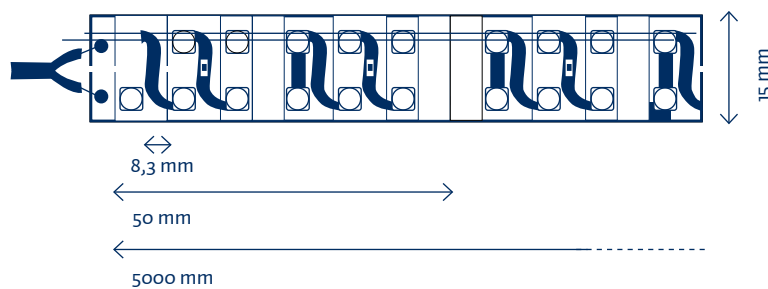

	COLOR COLOR	PROTECCIÓN PROTECTION	ALIMENTACIÓN POWER SUPPLY	TIPO LED LED TYPE	CANT. mts Qty OF LED	FLUJO LUM. LUM. FLOW	CONSUMO CONSUME
TF5R-1200-IP66	█	IP66	24V DC	3528	240 LEDS/ m	480lm/m	19,2W/ m
TF5AB-1200-IP66	█	IP66	24V DC	3528	240 LEDS/ m	480lm/m	19,2W/ m
TF5AZ-1200-IP66	█	IP66	24V DC	3528	240 LEDS/ m	600lm/m	19,2W/ m
TF5V-1200-IP66	█	IP66	24V DC	3528	240 LEDS/ m	560lm/m	19,2W/ m
TF5BF-1200-IP66	6000 K	IP66	24V DC	3528	240 LEDS/ m	1560lm/m	19,2W/ m
TF5BC-1200-IP66	3000 K	IP66	24V DC	3528	240 LEDS/ m	1440lm/m	19,2W/ m

Fuente de alimentación recomendada para un rollo de 5 mts LRS15024 / Recommended power supply for a 5 mts roll: LRS15024



TIRAS FLEXIBLES MONOCOLOR 240 LEDS/m

3528 IP68

SINGLE-COLOR FLEXIBLE STRIPS

240 LEDS/m 3528 IP68



Rollo de tira flexible de 5 mts monocolor 240 LEDS/m 3528. Se puede cortar cada 12 LEDS (50mm). Se suministra con adhesivo 3M de doble cara. Protección IP68.

5 mts Flexible strip roll single-color with 240 LEDS/m 3528. Can be cut every 12 LEDS (50mm). Provided with 3M double side adhesive. IP66 protection.

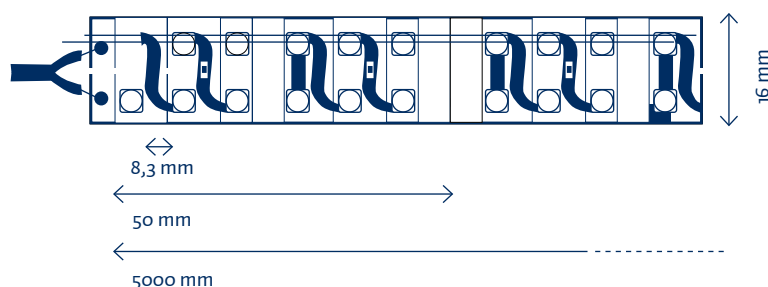

	COLOR COLOR	PROTECCIÓN PROTECTION	ALIMENTACIÓN POWER SUPPLY	TIPO LED LED TYPE	CANT. mts Qty OF LED	FLUJO LUM. LUM. FLOW	CONSUMO CONSUME
TF5R-1200-IP68	█	IP68	24V DC	3528	240 LEDS/ m	480lm/m	19,2W/ m
TF5AB-1200-IP68	█	IP68	24V DC	3528	240 LEDS/ m	480lm/m	19,2W/ m
TF5AZ-1200-IP68	█	IP68	24V DC	3528	240 LEDS/ m	600lm/m	19,2W/ m
TF5V-1200-IP68	█	IP68	24V DC	3528	240 LEDS/ m	560lm/m	19,2W/ m
TF5BF-1200-IP68	6000 K	IP68	24V DC	3528	240 LEDS/ m	1560lm/m	19,2W/ m
TF5BC-1200-IP68	3000 K	IP68	24V DC	3528	240 LEDS/ m	1440lm/m	19,2W/ m

Fuente de alimentación recomendada para un rollo de 5 mts LPV15024 / Recommended power supply for a 5 mts roll: LPV15024



TIRAS FLEXIBLES MONOCOLOR O RGB

30 LEDS/m 5050 IP33

RGB OR SINGLE-COLOR FLEXIBLE STRIPS

30 LEDS/m 5050 IP33



Rollo de tira flexible de 5 mts monocolor o RGB con 30 LEDS/m 5050. Se puede cortar cada 3 LEDS (100mm). Se suministra con adhesivo 3M de doble cara. Protección IP33. 36W de consumo total el rollo de 5 mts.

5 mts Flexible strip roll single-color or RGB with 30 LEDS/m 5050. Can be cut every 3 LEDS (100mm). Provided with 3M double side adhesive. IP33 protection. 5 mts roll total consume is 36W.

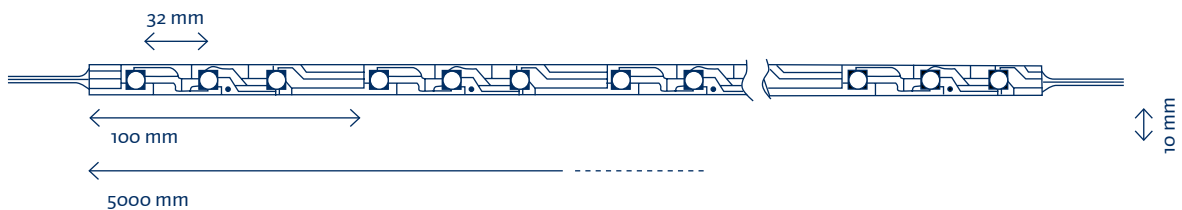

	COLOR COLOR	PROTECCIÓN PROTECTION	ALIMENTACIÓN POWER SUPPLY	TIPO LED LED TYPE	CANT. mts Qty OF LED	FLUJO LUM. LUM. FLOW	CONSUMO CONSUME
TF5R-AP		IP 33	12V DC	5050	30 LEDS/m	180lm/m	7,2W/ m
TF5AB-AP		IP 33	12V DC	5050	30 LEDS/m	180lm/m	7,2W/ m
TF5AZ-AP		IP 33	12V DC	5050	30 LEDS/m	225lm/m	7,2W/ m
TF5V-AP		IP 33	12V DC	5050	30 LEDS/m	360lm/m	7,2W/ m
TF5BF-AP	6000 K	IP 33	12V DC	5050	30 LEDS/m	585lm/m	7,2W/ m
TF5BD-AP	4000 K	IP 33	12V DC	5050	30 LEDS/m	570lm/m	7,2W/ m
TF5BC-AP	3000 K	IP 33	12V DC	5050	30 LEDS/m	550lm/m	7,2W/ m
TF5BSC-AP	2700K	IP 33	12V DC	5050	30 LEDS/m	540lm/m	7,2W/ m
TF5-AP-2300K	2300K	IP 33	12V DC	5050	30 LEDS/m	530lm/m	7,2W/ m
TF5RGB		IP 33	12V DC	5050	30 LEDS/m	60-120-75lm/m	7,2W/ m

Fuente de alimentación recomendada para un rollo de 5 mts LRS5012 (12V 50W) Para la tira RGB escoger también un controlador PWM /
Recommended power supply for a 5 mts roll: LRS5012 (12V 50W). For RGB strip also opt for a controller PWM



TIRAS FLEXIBLES MONOCOLOR O RGB 30 LEDS/m 5050 IP66

RGB OR SINGLE-COLOR FLEXIBLE STRIPS 30 LEDS/m 5050 IP66



Rollo de tira flexible de 5 mts monocolor o RGB con 30 LEDS/m 5050. Se puede cortar cada 3 LEDS (100mm). Se suministra con adhesivo 3M de doble cara. Protección IP66. 36W de consumo total el rollo de 5 mts.

5 mts Flexible strip roll single-color or RGB with 30 LEDS/m 5050. Can be cut every 3 LEDS (100mm). Provided with 3M double side adhesive. IP66 protection. 5 mts roll total consume is 36W.

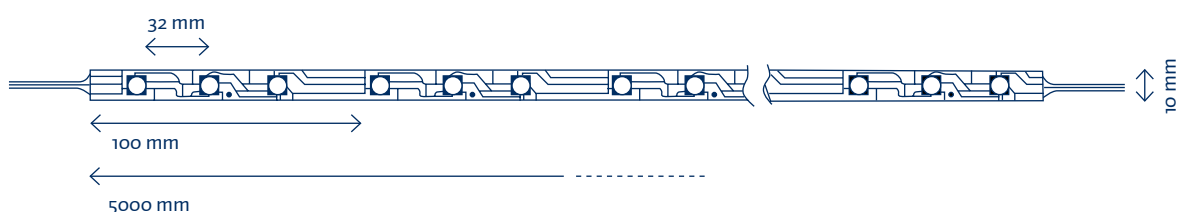

	COLOR COLOR	PROTECCIÓN PROTECTION	ALIMENTACIÓN POWER SUPPLY	TIPO LED LED TYPE	CANT. mts Qty OF LED	FLUJO LUM. LUM. FLOW	CONSUMO CONSUME
TF5R-AP-IP66		IP66	12V DC	5050	30 LEDS/m	180lm/m	7,2W/ m
TF5AB-AP-IP66		IP66	12V DC	5050	30 LEDS/m	180lm/m	7,2W/ m
TF5AZ-AP-IP66		IP66	12V DC	5050	30 LEDS/m	225lm/m	7,2W/ m
TF5V-AP-IP66		IP66	12V DC	5050	30 LEDS/m	360lm/m	7,2W/ m
TF5BF-AP-IP66	6000 K	IP66	12V DC	5050	30 LEDS/m	585lm/m	7,2W/ m
TF5BD-AP-IP66	4000 K	IP66	12V DC	5050	30 LEDS/m	570lm/m	7,2W/ m
TF5BC-AP-IP66	3000 K	IP66	12V DC	5050	30 LEDS/m	550lm/m	7,2W/ m
TF5BSC-AP-IP66	2700K	IP66	12V DC	5050	30 LEDS/m	540lm/m	7,2W/ m
TF5-AP-2300K-IP66	2300K	IP66	12V DC	5050	30 LEDS/m	530lm/m	7,2W/ m
TF5RGB-IP66		IP66	12V DC	5050	30 LEDS/m	60-120-75lm/m	7,2W/ m

Fuente de alimentación recomendada para un rollo de 5 mts LRS5012 (12V 50W). Para la tira RGB escoger también un controlador PWM /
Recommended power supply for a 5 mts roll: LRS5012 (12V 50W). For RGB strip also opt for a controller PWM



TIRAS FLEXIBLES MONOCOLOR O RGB 30 LEDS/m 5050 IP68

RGB OR SINGLE-COLOR FLEXIBLE STRIPS 30 LEDS/m 5050 IP68



Rollo de tira flexible de 5 mts monocolor o RGB con 30 LEDS/m 5050. Se puede cortar cada 3 LEDS (100mm). Se suministra con adhesivo 3M de doble cara. Protección IP68. 36W de consumo total el rollo de 5 mts.

5 mts Flexible strip roll single-color or RGB with 30 LEDS/m 5050. Can be cut every 3 LEDS (100mm). Provided with 3M double side adhesive. IP68 protection. 5 mts roll total consume is 36W.

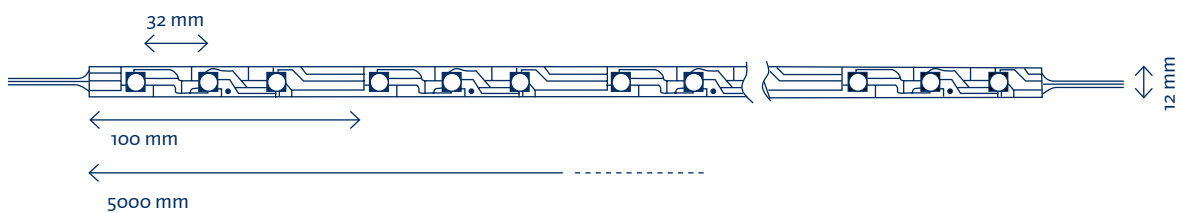

	COLOR COLOR	PROTECCIÓN PROTECTION	ALIMENTACIÓN POWER SUPPLY	TIPO LED LED TYPE	CANT. mts Qty OF LED	FLUJO LUM. LUM. FLOW	CONSUMO CONSUME
TF5R-AP-IP68	█	IP68	12V DC	5050	30 LEDS/m	180lm/m	7,2W/ m
TF5AB-AP-IP68	█	IP68	12V DC	5050	30 LEDS/m	180lm/m	7,2W/ m
TF5AZ-AP-IP68	█	IP68	12V DC	5050	30 LEDS/m	225lm/m	7,2W/ m
TF5V-AP-IP68	█	IP68	12V DC	5050	30 LEDS/m	360lm/m	7,2W/ m
TF5BF-AP-IP68	6000 K	IP68	12V DC	5050	30 LEDS/m	585lm/m	7,2W/ m
TF5BC-AP-IP68	3000 K	IP68	12V DC	5050	30 LEDS/m	540lm/m	7,2W/ m
TF5RGB-IP68	█ █ █	IP68	12V DC	5050	30 LEDS/m	60-120-75lm/m	7,2W/ m

Fuente de alimentación recomendada para un rollo de 5 mts LPV6012 (12V 60W). Para la tira RGB escoger también un controlador PWM /
Recommended power supply for a 5 mts roll: LPV6012 (12V 60W). For RGB strip also opt for a controller PWM



TIRAS FLEXIBLES MONOCOLOR O RGB

60 LEDS/m 5050 IP33

RGB OR SINGLE-COLOR FLEXIBLE STRIPS

60 LEDS/m 5050 IP33



Rollo de tira flexible de 5 mts monocolor o RGB con 60 LEDS/m 5050. Se puede cortar cada 6 LEDS (100mm). Se suministra con adhesivo 3M de doble cara. Protección IP33. 72W de consumo total el rollo de 5 mts.

5 mts Flexible strip roll single-color or RGB with 60 LEDS/m 5050. Can be cut every 3 LEDS (100mm). Provided with 3M double side adhesive. IP33 protection. 5 mts roll total consume is 72W.

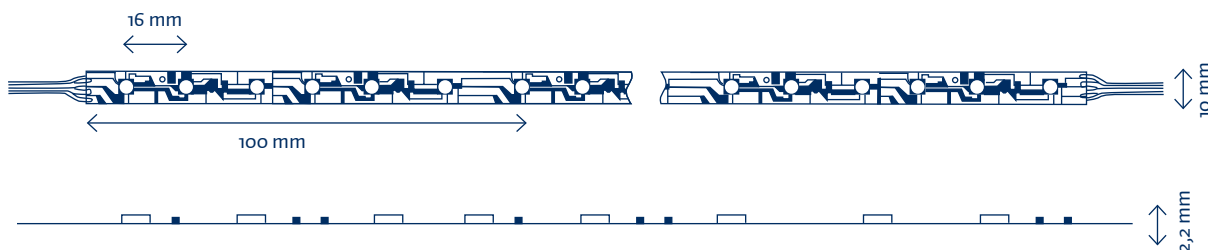

	COLOR COLOR	PROTECCIÓN PROTECTION	ALIMENTACIÓN POWER SUPPLY	TIPO LED LED TYPE	CANT. mts Qty OF LED	FLUJO LUM. LUM. FLOW	CONSUMO CONSUME
TF5R-AP-300		IP33	24V DC	5050	60 LEDS/m	360lm/m	14,4W/ m
TF5AB-AP-300		IP33	24V DC	5050	60 LEDS/m	360lm/m	14,4W/ m
TF5AZ-AP-300		IP33	24V DC	5050	60 LEDS/m	450lm/m	14,4W/ m
TF5V-AP-300		IP33	24V DC	5050	60 LEDS/m	720lm/m	14,4W/ m
TF5BF-AP-300	6000 K	IP33	24V DC	5050	60 LEDS/m	1170lm/m	14,4W/ m
TF5BD-AP-300	4000 K	IP33	24V DC	5050	60 LEDS/m	1162lm/m	14,4W/ m
TF5BC-AP-300	3000 K	IP33	24V DC	5050	60 LEDS/m	1140lm/m	14,4W/ m
TF5BSC-AP-300	2700K	IP33	24V DC	5050	60 LEDS/m	1122lm/m	14,4W/ m
TF5-AP-300-2300K	2300K	IP33	24V DC	5050	60 LEDS/m	1101lm/m	14,4W/ m
TF5RGB-300		IP33	24V DC	5050	60 LEDS/m	120-240-150lm/m	14,4W/ m

Fuente de alimentación recomendada para un rollo de 5 mts LRS10024 (24V 100W). Para la tira RGB escoger también un controlador PWM / Recommended power supply for a 5 mts roll: LRS10024 (24V 100W). For RGB strip also opt for a controller PWM



TIRAS FLEXIBLES MONOCOLOR O RGB 60 LEDS/m 5050 IP66

RGB OR SINGLE-COLOR FLEXIBLE STRIPS 60 LEDS/m 5050 IP66



Rollo de tira flexible de 5 mts monocolor o RGB con 60 LEDS/m 5050. Se puede cortar cada 6 LEDS (100mm). Se suministra con adhesivo 3M de doble cara. Protección IP66. 72W de consumo total el rollo de 5 mts.

5 mts Flexible strip roll single-color or RGB with 60 LEDS/m 5050. Can be cut every 3 LEDS (100mm). Provided with 3M double side adhesive. IP366 protection. 5 mts roll total consume is 72W.

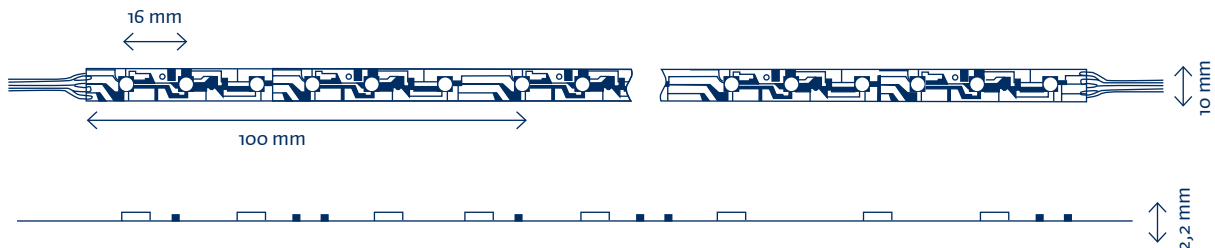

	COLOR COLOR	PROTECCIÓN PROTECTION	ALIMENTACIÓN POWER SUPPLY	TIPO LED LED TYPE	CANT. mts Qty OF LED	FLUJO LUM. LUM. FLOW	CONSUMO CONSUME
TF5R-AP-300-IP66	█	IP66	24V DC	5050	60 LEDS/m	360lm/m	14,4W/ m
TF5AB-AP-300-IP66	█	IP66	24V DC	5050	60 LEDS/m	360lm/m	14,4W/ m
TF5AZ-AP-300-IP66	█	IP66	24V DC	5050	60 LEDS/m	450lm/m	14,4W/ m
TF5V-AP-300-IP66	█	IP66	24V DC	5050	60 LEDS/m	720lm/m	14,4W/ m
TF5BF-AP-300-IP66	6000 K	IP66	24V DC	5050	60 LEDS/m	1170lm/m	14,4W/ m
TF5BD-AP-300-IP66	4000 K	IP66	24V DC	5050	60 LEDS/m	1162lm/m	14,4W/ m
TF5BC-AP-300-IP66	3000 K	IP66	24V DC	5050	60 LEDS/m	1140lm/m	14,4W/ m
TF5BSC-AP-300-IP66	2700K	IP66	24V DC	5050	60 LEDS/m	1122lm/m	14,4W/ m
TF5-AP-300-2300K-IP66	2300K	IP66	24V DC	5050	60 LEDS/m	1101lm/m	14,4W/ m
TF5RGB-300-IP66	█ █ █	IP66	24V DC	5050	60 LEDS/m	120-240-150lm/m	14,4W/ m

Fuente de alimentación recomendada para un rollo de 5mts: LRS10024 (24V 100W). Para la tira RGB escoger también un controlador PWM / Recommended power supply for a 5 mts roll: LRS10024 (24V 100W). For RGB strip also opt for a controller PWM



TIRAS FLEXIBLES MONOCOLOR O RGB 60 LEDS/m 5050 IP68

RGB OR SINGLE-COLOR FLEXIBLE STRIPS 60 LEDS/m 5050 IP68



Rollo de tira flexible de 5 mts monocolor o RGB con 60 LEDS/m 5050. Se puede cortar cada 6 LEDS (100mm). Se suministra con adhesivo 3M de doble cara. Protección IP68. 72W de consumo total el rollo de 5 mts.

5 mts Flexible strip roll single-color or RGB with 60 LEDS/m 5050. Can be cut every 6 LEDS (100mm). Provided with 3M double side adhesive. IP68 protection. Total consume of the 5 mts roll: 72W.

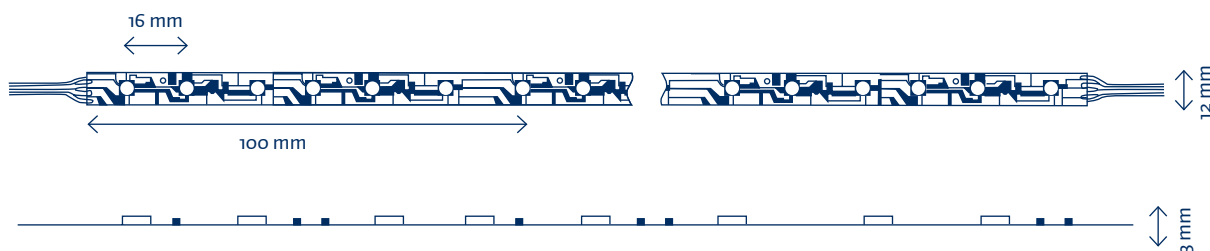

	COLOR COLOR	PROTECCIÓN PROTECTION	ALIMENTACIÓN POWER SUPPLY	TIPO LED LED TYPE	CANT. mts Qty OF LED	FLUJO LUM. LUM. FLOW	CONSUMO CONSUME
TF5R-AP-300-IP68	█	IP68	24V DC	5050	60 LEDS/m	360lm/m	14,4W/ m
TF5AB-AP-300-IP68	█	IP68	24V DC	5050	60 LEDS/m	360lm/m	14,4W/ m
TF5AZ-AP-300-IP68	█	IP68	24V DC	5050	60 LEDS/m	450lm/m	14,4W/ m
TF5V-AP-300-IP68	█	IP68	24V DC	5050	60 LEDS/m	720lm/m	14,4W/ m
TF5BF-AP-300-IP68	6000 K	IP68	24V DC	5050	60 LEDS/m	1170lm/m	14,4W/ m
TF5BC-AP-300-IP68	3000 K	IP68	24V DC	5050	60 LEDS/m	1140lm/m	14,4W/ m
TF5RGB-300-IP68	█ █ █	IP68	24V DC	5050	60 LEDS/m	120-240-150lm/m	14,4W/ m

Fuente de alimentación recomendada para un rollo de 5 mts LPV10024 (24V 100W). Para la tira RGB escoger también un controlador PWM /
Recommended power supply for a 5 mts roll: LPV10024 (24V 100W). For RGB strip also opt for a controller PWM



TIRAS FLEXIBLES MONOCOLOR 60 LEDS/m

5630 IP33 HP

SINGLE-COLOR FLEXIBLE STRIPS

60 LEDS/m 5630 IP33 HP



Rollo de tira flexible de 5mts monocolor 60 LEDS/m 5630 de alta potencia. Se puede cortar cada 6 leds (100mm). Se suministra con adhesivo 3M de doble cara. Protección IP33. 144W/5m consumo total del rollo de 5m.

5mt Flexible strip roll single-color with 60 LEDS/m 5630 High Power. Can be cut every 6LEDs (100mm). Provided with 3M double side adhesive. IP33 protection. 5 mts roll total consume is 144W.

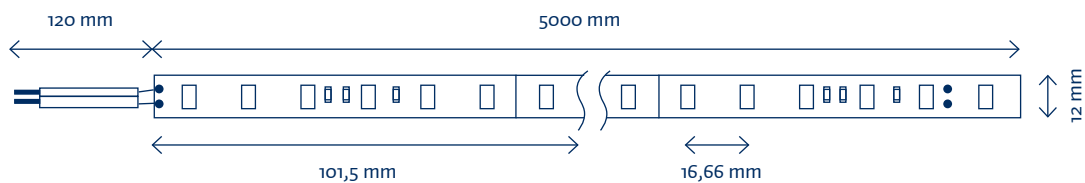

	COLOR COLOR	PROTECCIÓN PROTECTION	ALIMENTACIÓN POWER SUPPLY	TIPO LED LED TYPE	CANT. mts Qty OF LED	FLUJO LUM. LUM. FLOW	CONSUMO CONSUME
TF5BF-HP-300	6000 K	IP33	24VDC	5630	60 LEDS/m	2280lm/m	28,8W/m
TF5BD-HP-300	4000 K	IP33	24VDC	5630	60 LEDS/m	2120lm/m	28,8W/m
TF5BC-HP-300	3000 K	IP33	24VDC	5630	60 LEDS/m	2050lm/m	28,8W/m

Fuente de alimentación recomendada para un rollo de 5mts RSP20024 (24V 200W) / Recommended power supply for a 5mt roll: RSP20024 (24V 200W)



TIRAS FLEXIBLES MONOCOLOR 96 LEDS/m 2835 SAP

SINGLE-COLOR FLEXIBLE STRIPS 96 LEDS/m 2835 SAP



Rollo de tira flexible de 5mts monocolor 96 LEDS/m SMD 2835. Se puede cortar cada 6leds (60mm). Se suministra con adhesivo 3M de doble cara. Protección IP33. 144W/5m consumo total del rollo de 5m. Aplicaciones especiales para iluminar espacios desde grandes alturas.

5mt Flexible strip roll single-color with 96 LEDS/m SMD 2835. Can be cut every 6 LEDs (60mm). Provided with 3M double side adhesive. IP33 protection. 5 mts roll total consume is 144W.

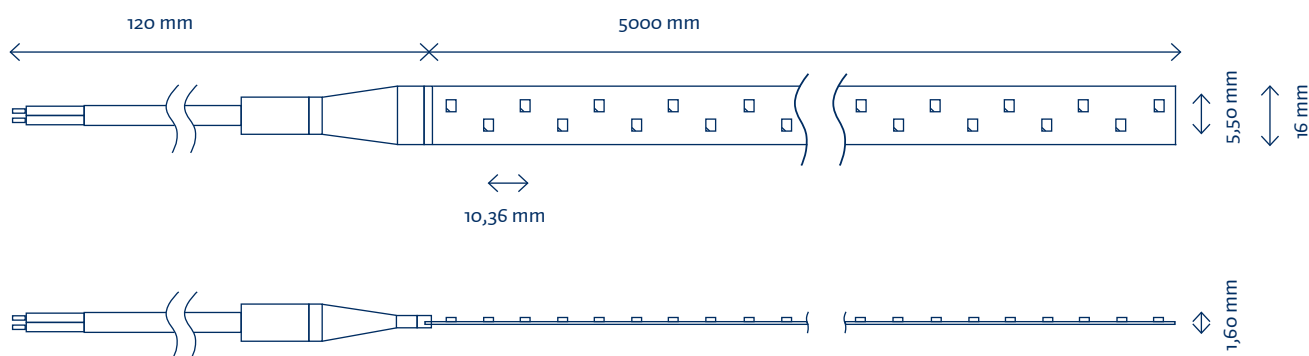

	COLOR COLOR	PROTECCIÓN PROTECTION	ALIMENTACIÓN POWER SUPPLY	TIPO LED LED TYPE	CANT. mts Qty OF LED	FLUJO LUM. LUM. FLOW	CONSUMO CONSUME
TF5BF-SAP	6000 K	IP33	24VDC	2835	96 LEDS/m	2250lm/m	28,8W/m
TF5BD-SAP	4000 K	IP33	24VDC	2835	96 LEDS/m	2200lm/m	28,8W/m
TF5BC-SAP	3000 K	IP33	24VDC	2835	96 LEDS/m	2100lm/m	28,8W/m

Fuente de alimentación recomendada para un rollo de 5mts RSP20024 (24V 200W) / Recommended power supply for a 5mt roll: RSP20024 (24V 200W)



28
/
29



TIRAS FLEXIBLES MONOCOLOR 120 LEDS/m

2835 IP33 RA95

SINGLE-COLOR FLEXIBLE STRIPS

120 LEDS/m 2835 IP33 RA95



Rollo de tira flexible de 5mts monocolor 120 LEDS/m SMD 2835. Se puede cortar cada 6leds (100mm). Se suministra con adhesivo 3M de doble cara. Protección IP33. 60W/5m consumo total del rollo de 5m. CRI95 para una reproducción de los colores idéntica a una fuente de luz natural. Aplicaciones especiales en tiendas de ropa y alimentación.

5mt Flexible strip roll single-color with 120 LEDS/m SMD 2835 Can be cut every 6 LEDs (100mm). Provided with 3M double side adhesive. IP33 protection. 5 mts roll total consume is 60W. CRI95 for colors reproduction identical to a natural light. Special applications in clothing and food.

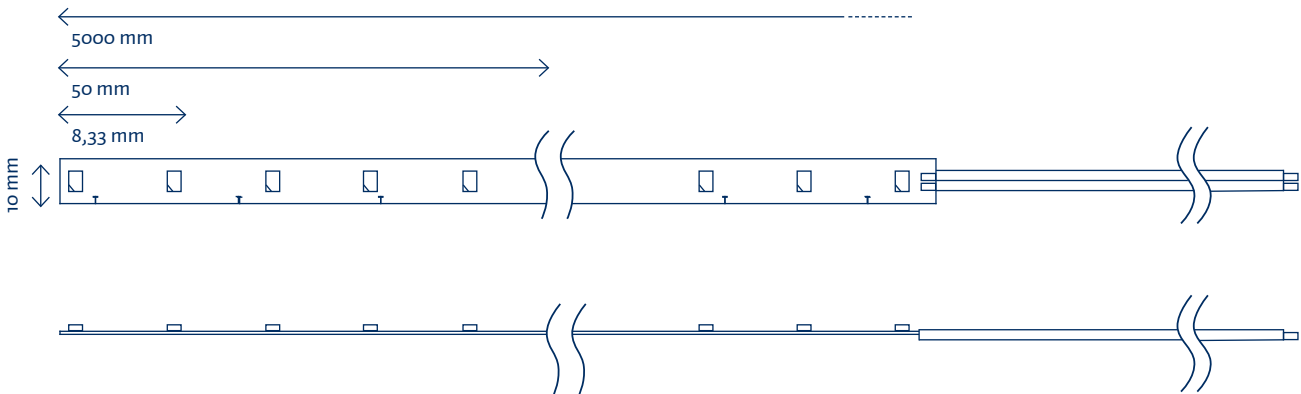

	COLOR COLOR	PROTECCIÓN PROTECTION	ALIMENTACIÓN POWER SUPPLY	TIPO LED LED TYPE	CANT. mts Qty OF LED	FLUJO LUM. LUM. FLOW	CONSUMO CONSUME
TF5BF-RA95-33	6000 K	IP33	24VDC	2835	120 LEDS/m	850lm /m	12W/m
TF5BD-RA95-33	4000 K	IP33	24VDC	2835	120 LEDS/m	822lm /m	12W/m
TF5BC-RA95-33	3000 K	IP33	24VDC	2835	120 LEDS/m	800lm /m	12W/m
TF5BSC-RA95-33	2700 K	IP33	24VDC	2835	120 LEDS/m	800lm /m	12W/m

Fuente de alimentación recomendada para un rollo de 5mts LRS10024 (24V 100W)/ Recommended power supply for a 5mt roll: LRS10024 (24V 100W)



TIRAS FLEXIBLES MONOCOLOR 120 LEDS/m 2835 IP66 RA95 SINGLE-COLOR FLEXIBLE STRIPS 120 LEDS/m 2835 IP66 RA95



Rollo de tira flexible de 5mts monocolor 120 LEDS/m SMD 2835. Se puede cortar cada 6leds (100mm). Se suministra con adhesivo 3M de doble cara. Protección IP66. 60W/5m consumo total del rollo de 5m. CRI95 para una reproducción de los colores idéntica a una fuente de luz natural. Aplicaciones especiales en tiendas de ropa y alimentación.

5mt Flexible strip roll single-color with 120 LEDS/m SMD 2835. Can be cut every 6 LEDs (100mm). Provided with 3M double side adhesive. IP66 protection. 5 mts roll total consume is 60W. CRI95 for colors reproduction identical to a natural light. Special applications in clothing and food.

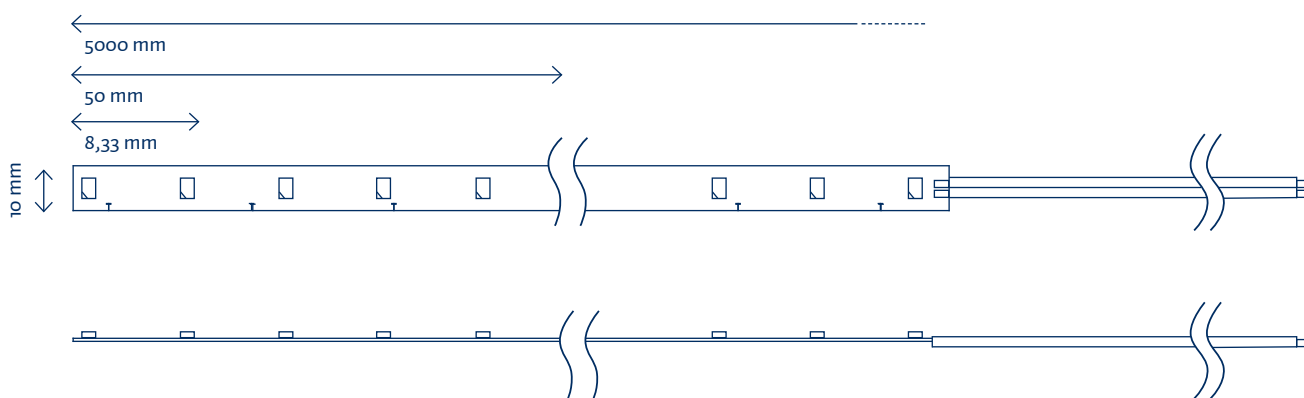

	COLOR COLOR	PROTECCIÓN PROTECTION	ALIMENTACIÓN POWER SUPPLY	TIPO LED LED TYPE	CANT. mts Qty OF LED	FLUJO LUM. LUM. FLOW	CONSUMO CONSUME
TF5BF-RA95-66	6000 K	IP66	24VDC	2835	120 LEDS/m	850lm/m	12W/m
TF5BD-RA95-66	4000 K	IP66	24VDC	2835	120 LEDS/m	822lm/m	12W/m
TF5BC-RA95-66	3000 K	IP66	24VDC	2835	120 LEDS/m	800lm/m	12W/m

Fuente de alimentación recomendada para un rollo de 5mts LRS10024 (24V 100W) / Recommended power supply for a 5mt roll: LRS10024 (24V 100W)



30
/
31



TIRAS FLEXIBLES MONOCOLOR 182 LEDS/m

2835 HP IP33 RA95

SINGLE-COLOR FLEXIBLE STRIPS

182 LEDS/m HP 2835 IP33 RA95



Rollo de tira flexible de 2,5 m monocolor 182LEDS/m SMD 2835. Se puede cortar cada 7leds (38mm). Se suministra con adhesivo 3M de doble cara. Protección IP33. 71W/2,5m consumo total del rollo de 5m. CRI95 para una reproducción de luz idéntica a la luz natural. Aplicaciones especiales para tiendas de ropa, calzado y alimentación.

2.5 m Flexible strip roll single-color with 182LEDS/m SMD 2835 Can be cut every 7leds (38mm). Provided with 3M double side adhesive. IP33 protection. 5 mts roll total consume is 71W/2,5m. CRI95 for colors reproduction identical to a natural light. Special applications in clothing and food.

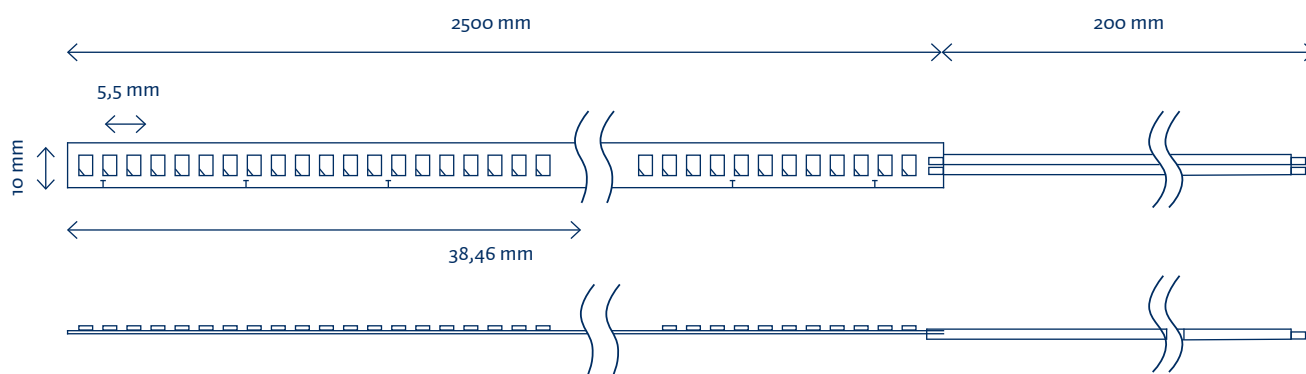

	COLOR COLOR	PROTECCIÓN PROTECTION	ALIMENTACIÓN POWER SUPPLY	TIPO LED LED TYPE	CANT. mts Qty OF LED	FLUJO LUM. LUM. FLOW	CONSUMO CONSUME
TF2.5BF-HP95-33	6000 K	IP33	24VDC	2835	182 LEDS/m	2190lm/m	28,4W/m
TF2.5BD-HP95-33	4000 K	IP33	24VDC	2835	182 LEDS/m	2096lm/m	28,4W/m
TF2.5BC-HP95-33	3000 K	IP33	24VDC	2835	182 LEDS/m	2000lm/m	28,4W/m
TF2.5BSC-HP95-33	2700 K	IP33	24VDC	2835	182 LEDS/m	2000lm/m	28,4W/m

Fuente de alimentación recomendada para un rollo de 2,5mts LRS15024 (24V 150W) / Recommended power supply for a 2,5mts roll: LRS15024 (24V 150W)



TIRAS FLEXIBLES RGBW 60 LEDS/m 5050 IP33

RGBW FLEXIBLE STRIPS 60 LEDS/m 5050 IP33



Rollo de tira flexible de 5mts RGBW 60 LEDS/m SMD 5050. A la cinta tradicional RGB se le incorpora el color blanco. Se puede cortar cada 3 leds (50mm). Se suministra con adhesivo 3M de doble cara. Protección IP33.

5mt Flexible strip roll single-color with 60 LEDS/m SMD 2835. Can be cut every 3 LEDs (50mm). To traditional RGB strip incorporates the white color. Provided with 3M double side adhesive. IP33 protection.

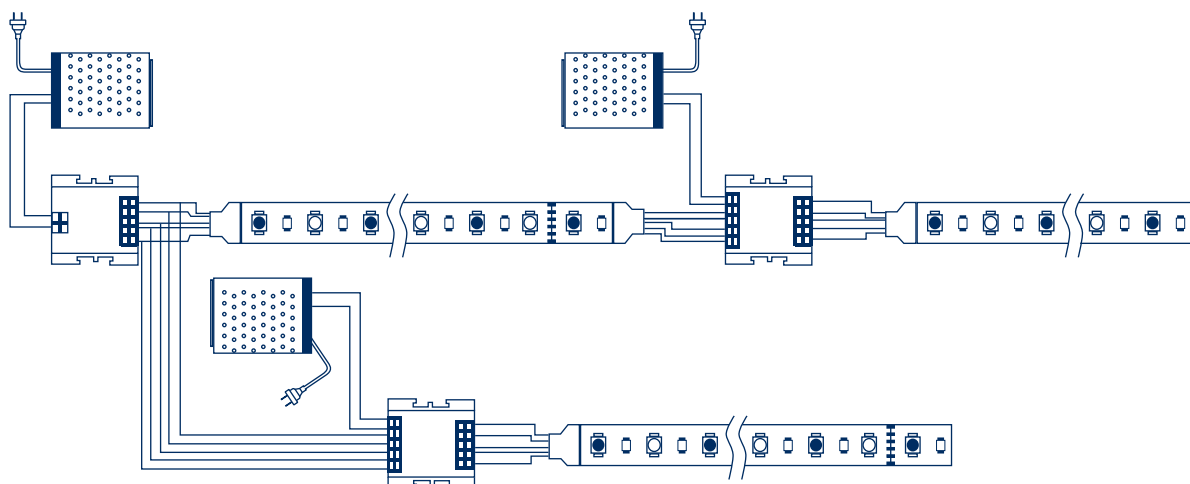
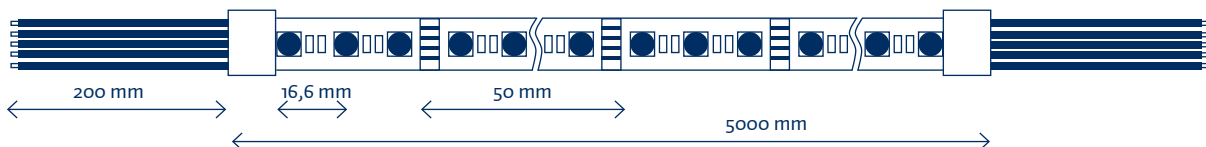

	COLOR COLOR	ALIMENTACIÓN POWER SUPPLY	TIPO LED LED TYPE	CANT. mts Qty OF LED	FLUJO LUM. LUM. FLOW	CONSUMO CONSUME
TF5RGBW-300	+6000 K	24VDC	5050	60 LEDS/m	500lm/m	18W/m
TF5RGBWW-300	+3000 K	24VDC	5050	60 LEDS/m	480lm/m	18W/m

Fuente de alimentación recomendada para un rollo de 5mts LRS10024 (24V 100W). Se necesita controlador de 4 canales para su funcionamiento / Recommended power supply for a 5mt roll: LRS10024 (24V 100W). 4 channel controller is needed for operation



TIRAS FLEXIBLES RGBW 60 LEDS/m 5050 IP66

RGBW FLEXIBLE STRIPS 60 LEDS/m 5050 IP66



Rollo de tira flexible de 5mts RGBW 60 LEDS/m SMD 5050. A la cinta tradicional RGB se le incorpora el color blanco. Se puede cortar cada 3 leds (50mm). Se suministra con adhesivo 3M de doble cara. Protección IP66.

5mt Flexible strip roll single-color with 60 LEDS/m SMD 5050. Can be cut every 3 LEDs (50mm). To traditional RGB strip incorporates the white color. Provided with 3M double side adhesive. IP66 protection.

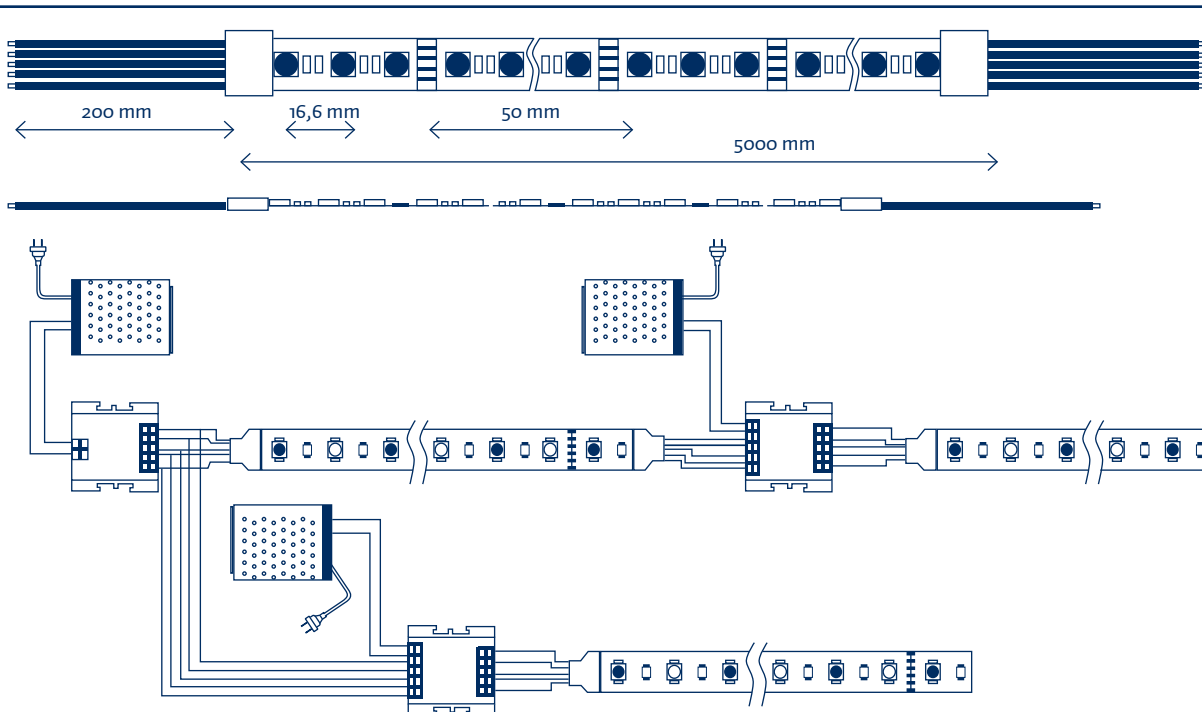

	COLOR COLOR	ALIMENTACIÓN POWER SUPPLY	TIPO LED LED TYPE	CANT. mts Qty OF LED	FLUJO LUM. LUM. FLOW	CONSUMO CONSUME
TF5RGBW-300-IP66	+6000 K	24VDC	5050	60 LEDS/m	500lm/m	18W/m
TF5RGBWW-300-IP66	+3000 K	24VDC	5050	60 LEDS/m	480lm/m	18W/m

Fuente de alimentación recomendada para un rollo de 5mts LRS10024 (24V 100W) / Recommended power supply for a 5mt roll: LRS10024 (24V 100W)

Rollo 50m

CRI90



TIRAS FLEXIBLES MONOCOLOR 60 LEDS/m 5050 IP33 EN ROLLO 50M SINGLE-COLOR FLEXIBLE STRIPS 60 LEDS/m 5050 IP33 ROLLS OF 50M



Rollo de tira flexible de 50mts monocolor con 60 LEDS/m SMD 5050. Se puede cortar cada 6 leds (100mm). Se suministra con adhesivo 3M de doble cara. Protección IP33. 12W/m de consumo. Especialmente ideado para su suministro por corte. Se recomienda no alimentar más de 8m en serie.

50mts Flexible strip roll single-color with 60 LEDS/m SMD 5050. It can be cut every 6 LEDs (100mm). Provided with 3M double-sided adhesive. IP33 protection. 12W / m consumer. Specially designed for delivery by cutting. It is recommended not feed more than 8m in series

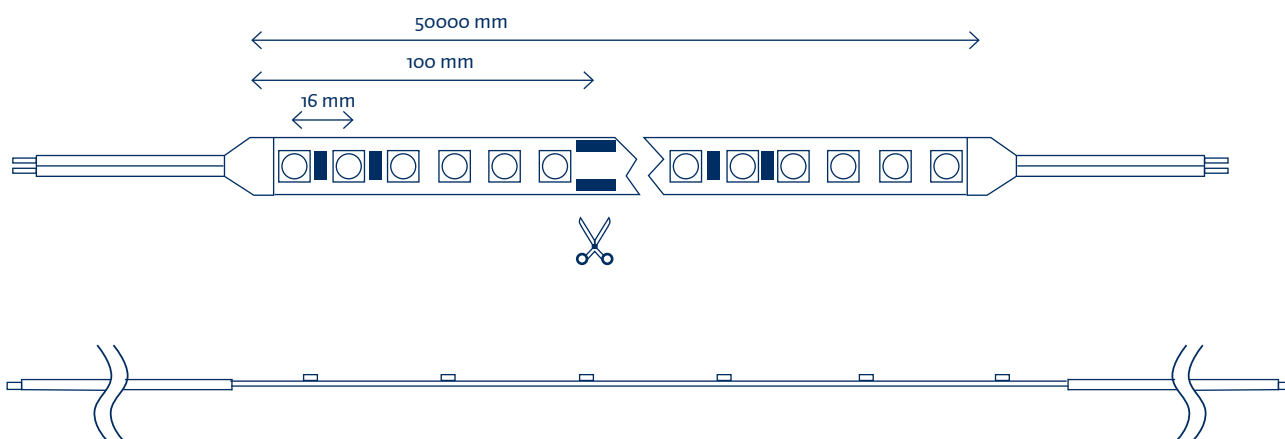

	COLOR COLOR	PROTECCIÓN PROTECTION	ALIMENTACIÓN POWER SUPPLY	TIPO LED LED TYPE	CANT. mts Qty OF LED	FLUJO LUM. LUM. FLOW	CONSUMO CONSUME
TF50BF-RA90-33	6000 K	IP33	24VDC	5050	60 LEDS/m	990lm/m	12W/m
TF50BD-RA90-33	4000 K	IP33	24VDC	5050	60 LEDS/m	960lm/m	12W/m
TF50BC-RA90-33	3000 K	IP33	24VDC	5050	60 LEDS/m	910lm/m	12W/m

Escoger fuente en función de cada corte./ Choose source cutting function

Rollo 50m

CRI90

34
35



TIRAS FLEXIBLES MONOCOLOR 60 LEDS/m 5050 IP66 EN ROLLO 50M

SINGLE-COLOR FLEXIBLE STRIPS 60 LEDS/m 5050 IP66 ROLLS OF 50M



Rollo de tira flexible de 50mts monocolor con 60 LEDS/m SMD 5050. Se puede cortar cada 6 leds (100mm). Se suministra con adhesivo 3m de doble cara. Protección IP66. 12W/m de consumo. Especialmente ideado para su suministro por corte. Se recomienda no alimentar más de 8m en serie.

50mts Flexible strip roll single-color with 60 LEDS/m SMD 5050. It can be cut every 6 LEDs (100mm). Provided with 3M double-sided adhesive. IP66 protection. 12W / m consumer. Specially designed for delivery by cutting. It is recommended not feed more than 8m in series.

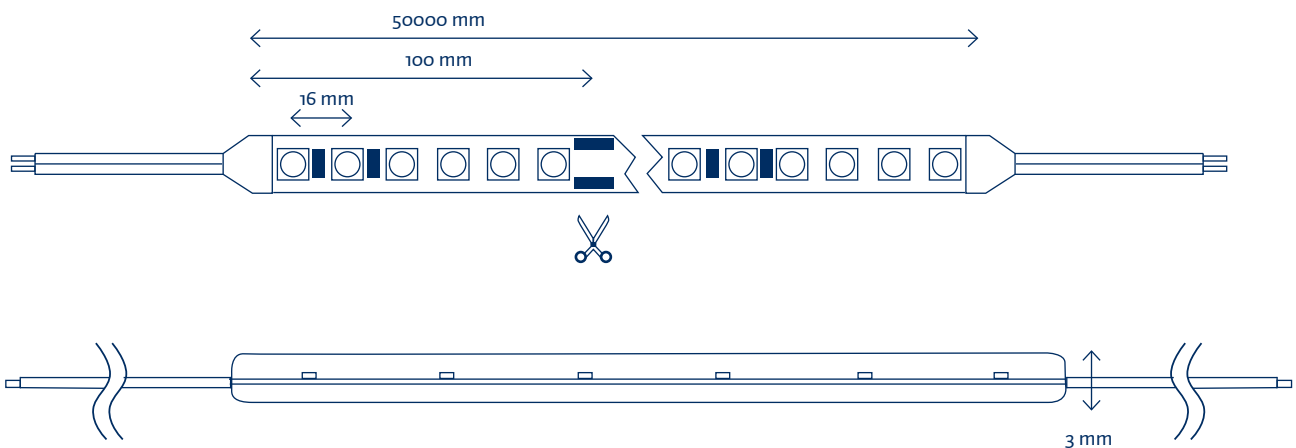

	COLOR COLOR	PROTECCIÓN PROTECTION	ALIMENTACIÓN POWER SUPPLY	TIPO LED LED TYPE	CANT. mts Qty OF LED	FLUJO LUM. LUM. FLOW	CONSUMO CONSUME
TF50BF-RA90-66	6000 K	IP66	24VDC	5050	60 LEDS/m	990lm/m	12W/m
TF50BD-RA90-66	4000 K	IP66	24VDC	5050	60 LEDS/m	960lm/m	12W/m
TF50BC-RA90-66	3000 K	IP66	24VDC	5050	60 LEDS/m	910lm/m	12W/m

Escoger fuente en función de cada corte / Choose source cutting function



TIRAS FLEXIBLES MONOCOLOR Y RGB

60 LEDS/m IP68 A 230VAC

SINGLE-COLOR AND RGB FLEXIBLE STRIPS

60 LEDS/m IP68 FOR 230VAC



Rollo de tira flexible de 50mts monocolor y RGB 60 LEDS/m SMD 5050 y alimentación a 230VAC. Protección IP68. Se suministra en rollos de 50 mts. Se puede cortar cada metro.

SMD 5050 which can be directly connect 230VAC. IP68 protection. Provided 50 mts long rolls. Can be cut each meter 50mt Flexible strip roll single-color and RGB with 60 LEDS/m.

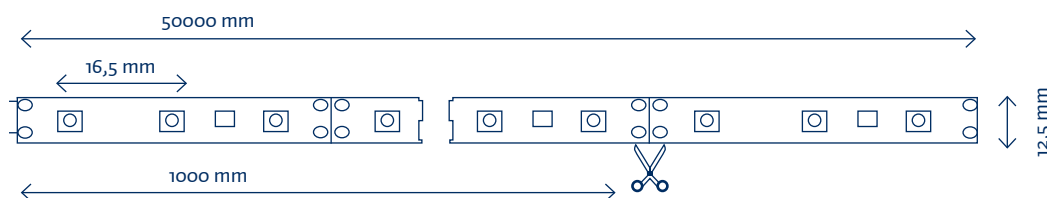

INSTALACIÓN RGB / INSTALLATION RGB

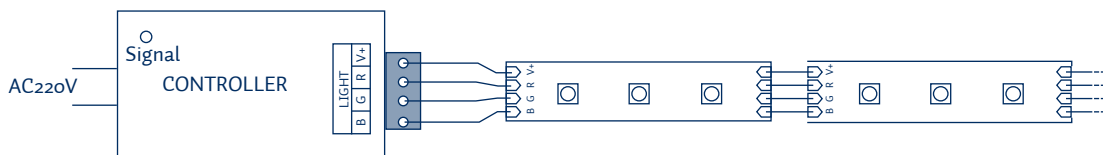

	COLOR COLOR	PROTECCIÓN PROTECTION	ALIMENTACIÓN POWER SUPPLY	TIPO LED LED TYPE	CANT. mts Qty OF LED	FLUJO LUM. LUM. FLOW	CONSUMO CONSUME
TF50-220V	6000 K	IP68	230VAC	5050	60 LEDS/m	720 lm/m	14,4W/m
TF50RGB-220V		IP68	230VAC	5050	60 LEDS/m	710 lm/m	14,4W/m
TF50BC-220V	3000 K	IP68	230VAC	5050	60 LEDS/m	710 lm/m	14,4W/m

ACCESORIOS / ACCESSORIES

CE-TIRA220VRGB	Conector Europeo con controlador RGB / European connector with RGB controller						
CE-TIRA220V	Conector Europeo para tira 230V con 50cm de cable / European Connector with 50cm of cable						
CF-TIRA220V	Conector final para tira 5050 230V / End connector						
CM-TIRA 220V	Conector de unión tira LED 5050 / Union connector						
CM-TIRA220VRGB	Conector de unión para tira RGB / Union connector for RGB strip						
GR-TIRA220V	Grapa para tira Led 5050 230v / Clip						
CF-TIRA220V-RGB	Conector Europeo para tira 230V RGB con 50cm de cable / European Connector with RGB 50cm of cable						

No necesita fuente de alimentación. Conexión directa 230VAC / No need power supply. Direct connection to 230VAC



TIRAS FLEXIBLES MONOCOLOR 224 LEDs/m

2835 IP33

SINGLE-COLOR FLEXIBLE STRIPS

224 LEDs/m 2835 IP33



Rollo de tira flexible de 5 mts monocolor 224LEDS/m 2835. Se puede cortar cada 8 LEDS (35,8mm). Se suministra con adhesivo 3M de doble cara. Protección IP33.

5 mts Flexible strip roll single-color with 224 LEDS/m 2835. Can be cut every 8 LEDS (35,8mm). Provided with 3M double side adhesive. IP33 protection.

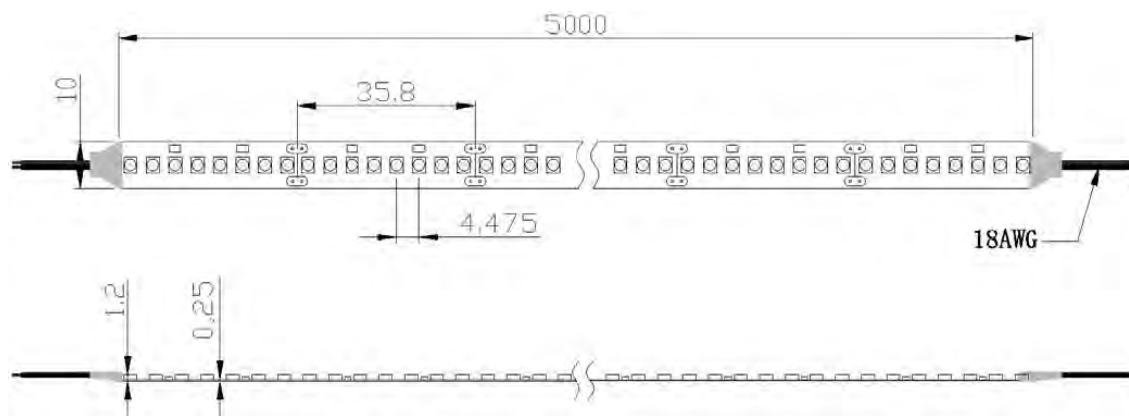

	COLOR COLOR	PROTECCIÓN PROTECTION	ALIMENTACIÓN POWER SUPPLY	TIPO LED LED TYPE	CANT. mts Qty OF LED	FLUJO LUM. LUM. FLOW	CONSUMO CONSUME
TF5BF-SHP	6000 K	IP33	24V DC	2835	224 LEDS/ m	2885lm/m	20,16W/ m
TF5BD-SHP	4000 K	IP33	24V DC	2835	224 LEDS/ m	2710lm/m	20,16W/ m
TF5BC-SHP	3000 K	IP33	24V DC	2835	224LEDS/ m	2600lm/m	20,16W/ m

Fuente de alimentación recomendada para un rollo de 5 mts LPV15024 / Recommended power supply for a 5 mts roll: LPV15024



TIRAS FLEXIBLES FLEXNEON FLEXNEON FLEXIBLE STRIPS



Tiras LED con sistema Flexneon ideales para iluminación perimetral en piscinas. Protección IP68. Recubrimiento especial para poder funcionar en agua de piscina. El modelo RGB se controla mediante los equipos PWM.

LED Neon Flex Strip lights ideal for perimeter lighting system pools. IP68 protection. Special to use in swimming pool. The RGB model is controlled by the PWM equipment.

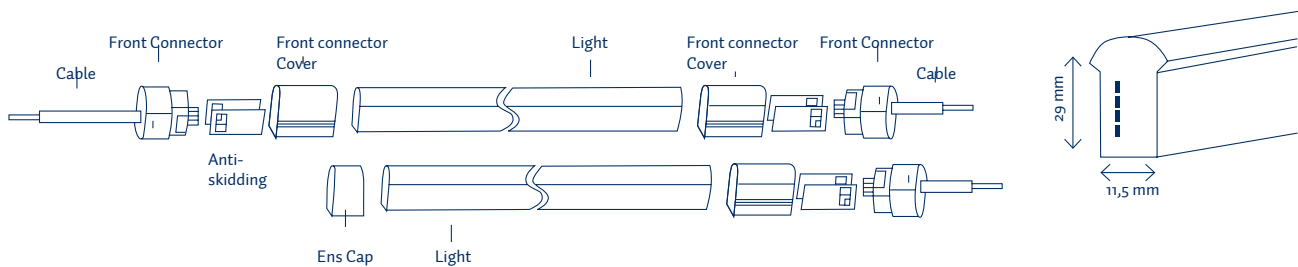

	COLOR COLOR	CONSUMO CONSUME	TENSIÓN VOLTAGE	LEDS/M	DESCRIPCIÓN DESCRIPTION
BS-NEON-T1-B	6000K	12 W/m	24V DC	60 leds 5050	Tubo flexneon blanco frío / Cool White flexneon tube
BS-NEON-T1-BC	3000K	12 W/m	24V DC	60 leds 5050	Tubo flexneon blanco cálido / Warm White flexneon tube
BS-NEON-T1-RGB		12 W/m	24V DC	60 leds 5050	Tubo flexneon RGB / RGB flexneon tube

DESCRIPCIÓN / DESCRIPTION

BS-NEON-C1-B	Conector inicial tubo blanco con protección IP68 / White tube initial connector with IP68 protection				
BS-NEON-C1-RGB	Conector inicial tubo RGB con protección IP68 / RGB tube initial connector with IP68 protection				
BS-NEON-F1	Conector final con protección IP68 / End connector with IP68 protection				
BS-NEON-P1	Perfil de plástico para tubo Flexneon / Plastic profile profile for Flexneon tube				

Escoger fuente en función de cada corte. / Choose source cutting function



TIRAS DIGITALES Y MÓDULOS

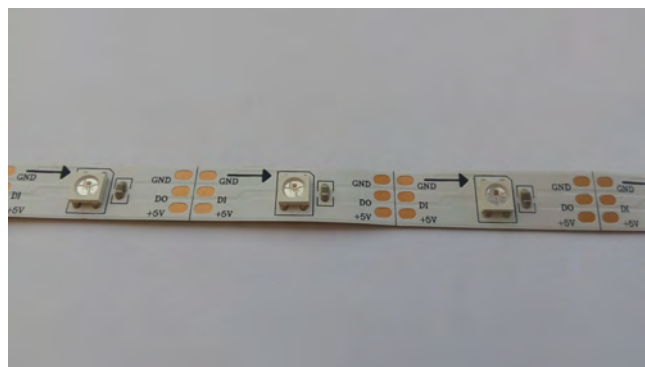

TIRAS FLEXIBLES 60 LEDS/m 5050 SERIE TFSMART/60-20

SERIE TFSMART/60-20 FLEXIBLE STRIPS 60LEDS/m 5050



Rollo de tira flexible de 5 mts con 60 LEDS/m SMD 5050 RGB. Cada LED dispone de un chip controlador para poder generar cientos de efectos diferentes. Se puede cortar cada 1 LED (1.6cm). Se suministra con adhesivo 3M de doble cara. Protección IP33. 90W de consumo total el rollo de 5mts.

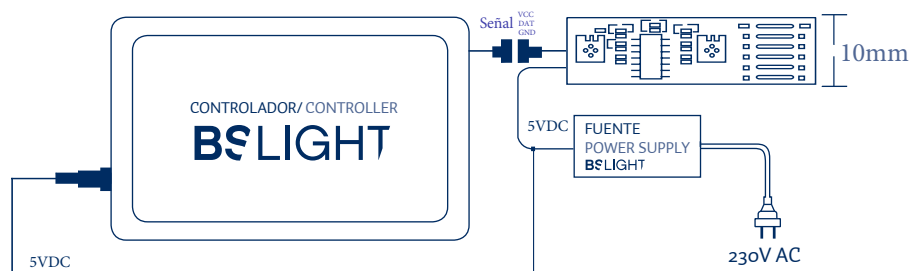
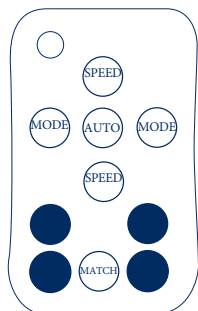

	DESCRIPCIÓN DESCRIPTION	COLOR COLOR	PROTECCIÓN PROTECTION	ALIMENTACIÓN POWER SUPPLY	TIPO LED LED TYPE	CANT. mts Qty OF LED	FLUJO LUM. LUM. FLOW	CONSUMO CONSUME
TFSMART/60-20	Tira 5 mts	RGB	IP33	5V DC	5050	60LEDS/m	R:90lm/m G:240lm/m B:90lm/m	18 W/m
CSMART/2	Controlador 125 Programas		IP33	5V DC	-	-	-	4W

Fuente de alimentación recomendada para un rollo de 5 mts LRS10024 (5V 100W). Para regular la tira LED TFSMART/60-20 es preciso la instalación del equipo CSMART/2

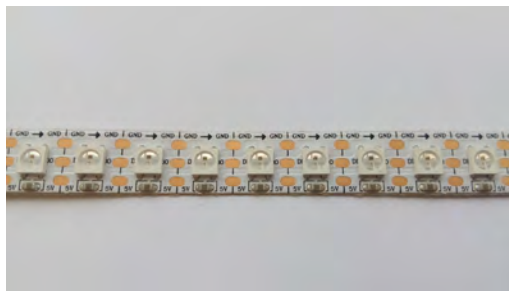

TIRAS FLEXIBLES 72 LEDS/m 5050 SERIE TFSMART/72-20

SERIE TFSMART/72-20 FLEXIBLE STRIPS 72LEDS/m 5050



Rollo de tira flexible de 5 mts con 72 LEDS/m SMD 5050 RGB. Cada LED dispone de un chip controlador para poder generar cientos de efectos diferentes. Se puede cortar cada 1 LED (1.5cm). Se suministra con adhesivo 3M de doble cara. Protección IP33. 108W de consumo total el rollo de 5mts.

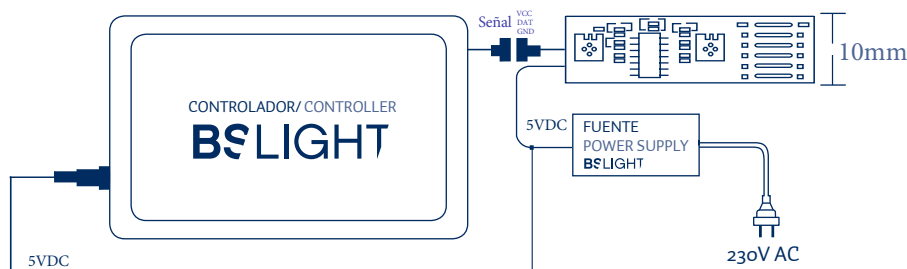
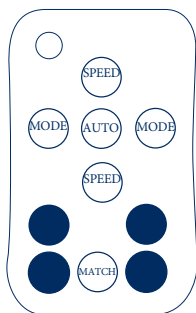

	DESCRIPCIÓN DESCRIPTION	COLOR COLOR	PROTECCIÓN PROTECTION	ALIMENTACIÓN POWER SUPPLY	TIPO LED LED TYPE	CANT. mts Qty of LED	FLUJO LUM. LUM. FLOW	CONSUMO CONSUME
TFSMART/72-20	Tira 5 mts		IP33	5V DC	5050	72LEDS/m	R:108lm/m G:288lm/m B:108lm/m	21,6 W/m
CSMART/2	Controlador 125 Programas		IP33	5V DC	-	-	-	4W

Fuente de alimentación recomendada para un rollo de 5 mts LRS15024 (5V 150W). Para regular la tira LED TFSMART/72-20 es preciso la instalación del equipo CSMART/2



TIRAS DIGITALES Y MÓDULOS

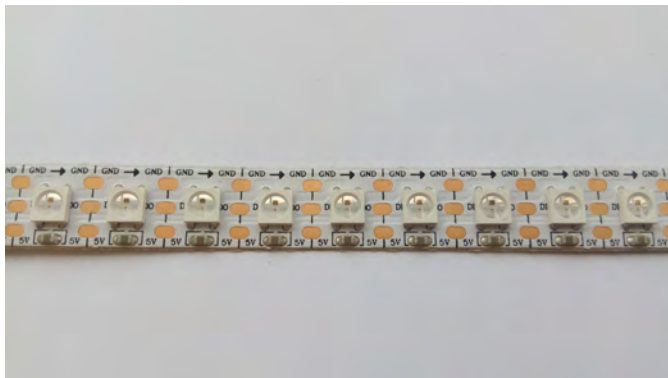

TIRAS Y MÓDULOS / STRIPS AND MODULES

TIRAS FLEXIBLES 96 LEDS/m 5050 SERIE TFSMART/96-20

SERIE TFSMART/96-20 FLEXIBLE STRIPS 96LEDS/m 5050



Rollo de tira flexible de 5 mts con 96 LEDS/m SMD 5050 RGB. Cada LED dispone de un chip controlador para poder generar cientos de efectos diferentes. Se puede cortar cada 1 LED (1cm). Se suministra con adhesivo 3M de doble cara. Protección IP33. 145W de consumo total el rollo de 5mts.

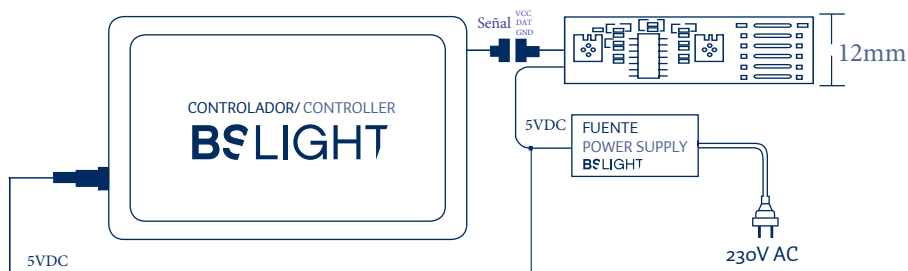
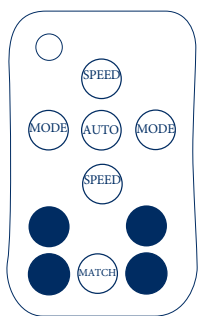

DESCRIPCIÓN DESCRIPTION	COLOR COLOR	PROTECCIÓN PROTECTION	ALIMENTACIÓN POWER SUPPLY	TIPO LED LED TYPE	CANT. mts Qty OF LED	FLUJO LUM. LUM. FLOW	CONSUMO CONSUME
TFSMART/96-20 Tira 5 mts	RGB	IP33	5V DC	5050	96LEDS/m	R:144lm/m G:384lm/m B:144lm/m	28,8W/m
CSMART/2 Controlador 125 Programas		IP33	5V DC	-	-	-	4W

Fuente de alimentación recomendada para un rollo de 5 mts RSP20024 (5V 200W). Para regular la tira LED TFSMART/96-20 es preciso la instalación del equipo CSMART/2



TIRAS DIGITALES Y MÓDULOS

TIRAS Y MÓDULOS / STRIPS AND MODULES



TIRAS FLEXIBLES 144 LEDS/m 5050 SERIE TFSMART/144-20

SERIE TFSMART/144-20 FLEXIBLE STRIPS

144 LED/5m 5050



Rollo de tira flexible de 5 mts con 144LEDS/m SMD 5050 RGB. Cada LED dispone de un chip controlador para poder generar cientos de efectos diferentes. Se puede cortar cada 1 LED (1.7cm). Se suministra con adhesivo 3M de doble cara. Protección IP33. 216 W de consumo total el rollo de 5mts.

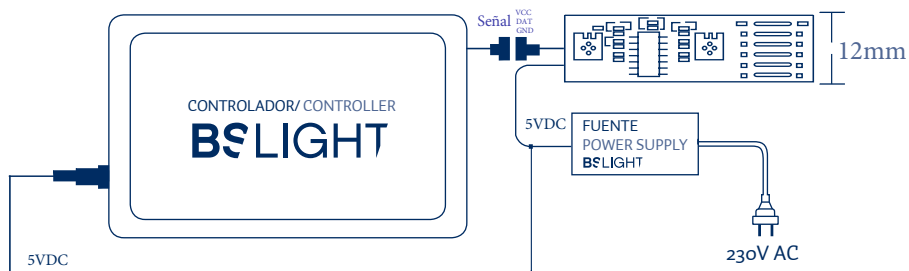
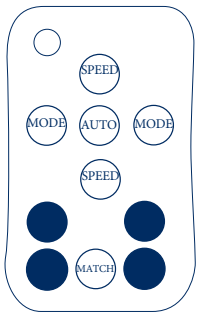

DESCRIPCIÓN DESCRIPTION	COLOR	PROTECCIÓN PROTECTION	ALIMENTACIÓN POWER SUPPLY	TIPO LED LED TYPE	CANT. mts Qty OF LED	FLUJO LUM. LUM. FLOW	CONSUMO CONSUME
TFSMART/144-20 Tira 5 mts		IP33	5V DC	5050	144LEDS/m	R:216lm/m G:576lm/m B:216lm/m	43.2W/m
CSMART/2 Controlador 125 Programas		IP33	5V DC	-	-	-	4W

Fuente de alimentación recomendada para un rollo de 5 mts SP24024 (5V 240W). Para regular la tira LED TFSMART/144-20 es preciso la instalación del equipo CSMART/2



TIRAS DIGITALES Y MÓDULOS



TIRAS FLEXIBLES 144 LEDS/m 5050 SERIE TFSMART/144-65

SERIE TFSMART/144-65 FLEXIBLE STRIPS

144 LED/5m 5050



Rollo de tira flexible de 5 mts con 144LEDS/m SMD 5050 RGB. Cada LED dispone de un chip controlador para poder generar cientos de efectos diferentes. Se puede cortar cada 1 LED (1.7cm). Se suministra con adhesivo 3M de doble cara. Protección IP66. 216 W de consumo total el rollo de 5mts.

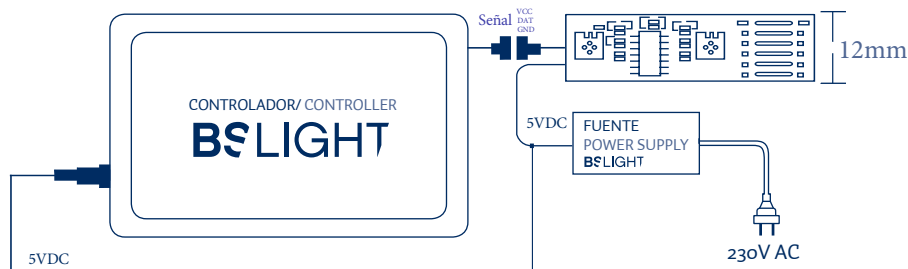
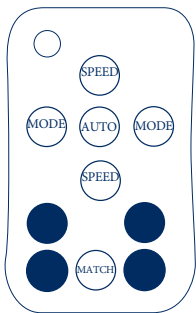

DESCRIPCIÓN DESCRIPTION	COLOR COLOR	PROTECCIÓN PROTECTION	ALIMENTACIÓN POWER SUPPLY	TIPO LED LED TYPE	CANT. mts Qty OF LED	FLUJO LUM. LUM. FLOW	CONSUMO CONSUME
TFSMART/144-65 Tira 5 mts		IP66	5V DC	5050	144LEDS/m	R:216lm/m G:576lm/m B:216lm/m	43.2W/m
CSMART/2 Controlador 125 Programas		IP33	5V DC	-	-	-	4W

Fuente de alimentación recomendada para un rollo de 5 mts SP24024 (5V 240W). Para regular la tira LED TFSMART/144-20 es preciso la instalación del equipo CSMART/2



TIRAS DIGITALES Y MÓDULOS

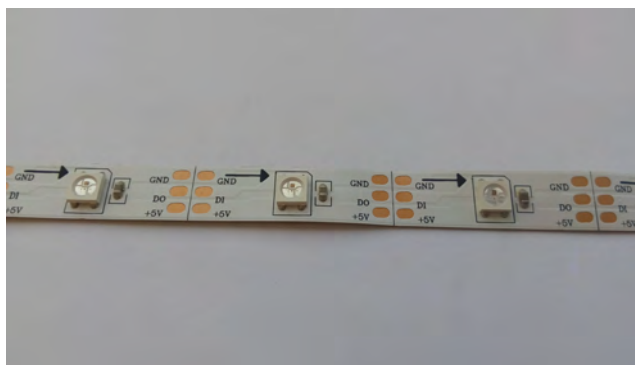

TIRAS FLEXIBLES 30 LEDS/m 5050 SERIE TFSMART/30-20

SERIE TFSMART/30-20 FLEXIBLE STRIPS 30LEDS/m 5050



Rollo de tira flexible de 5 mts con 30 LEDS/m SMD 5050 RGB. Cada LED dispone de un chip controlador para poder generar cientos de efectos diferentes. Se puede cortar cada 1 LED (3.3cm). Se suministra con adhesivo 3M de doble cara. Protección IP33. 45W de consumo total el rollo de 5mts.

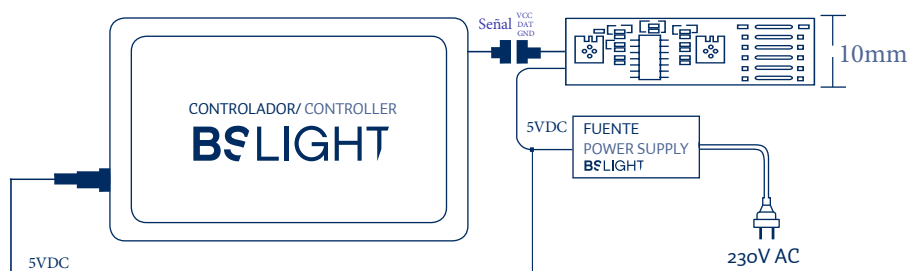
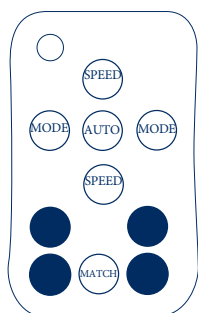

	DESCRIPCIÓN DESCRIPTION	COLOR COLOR	PROTECCIÓN PROTECTION	ALIMENTACIÓN POWER SUPPLY	TIPO LED LED TYPE	CANT. mts Qty OF LED	FLUJO LUM. LUM. FLOW	CONSUMO CONSUME
TFSMART/30-20	Tira 5 mts		IP33	5V DC	5050	30LEDS/m	R:45lm/m G:120lm/m B:45lm/m	9 W/m
CSMART/2	Controlador 125 Programas		IP33	5V DC	-	-		4W

Fuente de alimentación recomendada para un rollo de 5 mts LRS5024 (5V 240W). Para regular la tira LED TFSMART/30-20 es preciso la instalación del equipo CSMART/2



TIRAS FLEXIBLES 32 LEDS/m 5050

SERIE SMART

SERIE SMART FLEXIBLE STRIPS 32 LEDS/m 5050



Rollo de tira flexible de 5 mts con 32 LEDS/m SMD 5050 RGB. Cada grupo de 2 LEDS dispone de un chip controlador para poder generar cientos de efectos diferentes. Se puede cortar cada 2 LEDS (60mm). Se suministra con adhesivo 3M de doble cara. Protección IP66. 48W de consumo total el rollo de 5 mts.

5 mts flexible strip roll with 32 LEDS/m SMD 5050 RGB. Each 2 LEDS has a PC board to generat thousand of different effects. Can be cut every 2 LEDS (60mm). Provided with 3 mts double side adhesive. IP66 protection.5 mts roll total consume is 48W.

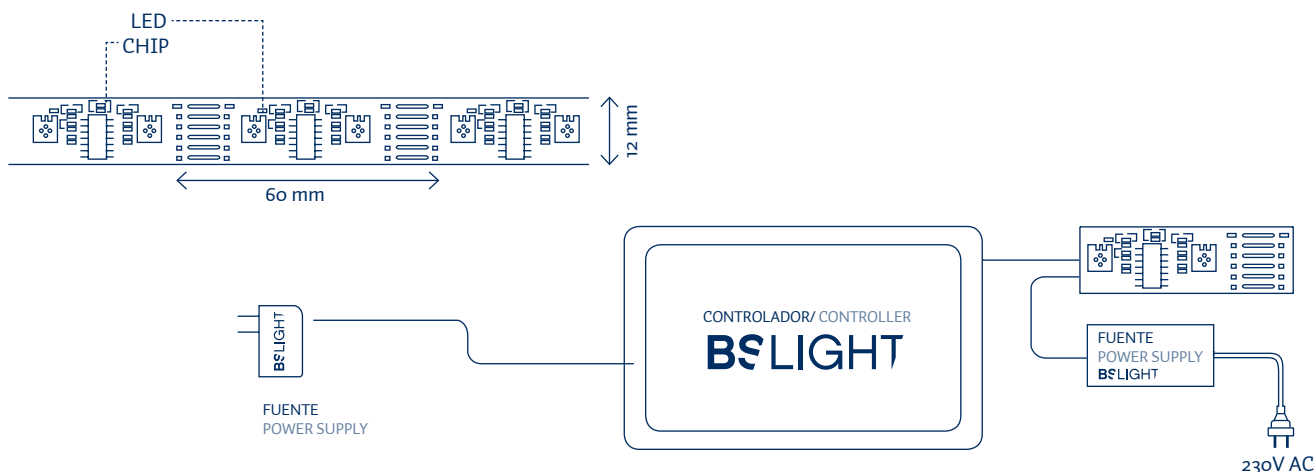

	DESCRIPCIÓN DESCRIPTION	COLOR COLOR	PROTECCIÓN PROTECTION	ALIMENTACIÓN POWER SUPPLY	TIPO LED LED TYPE	CANT. mts Qty OF LED	FLUJO LUM. LUM. FLOW	CONSUMO CONSUME
TFSMART	Tira 5 mts	RGB	IP65	5V DC	5050	32 LEDS/m	60-120-75lm/m	48W
CSMART	Controlador /Controller		IP33	12V DC	-	-	-	4W

Fuente de alimentación recomendada para un rollo de 5 mts RS550 (5V 50W). Para regular la tira LED SMART es preciso la instalación del equipo CSMART / Recommended power supply for a 5 mts roll: RS550 (5V 50W). To control the SMART flexible strip, the installation of the device CSMART is necessary.



TIRAS FLEXIBLES DUAL 60 LEDS/m 5050 BLANCO FRÍO + BLANCO CÁLIDO

DUAL FLEXIBLE STRIPS 60 LEDS/m 5050 COLD WHITE + WARM WHITE



Rollo de tira flexible de 5 mts DUAL con 60 LEDS/m SMD 5050. 150 LEDS en blanco frío y 150 LEDS en blanco cálido intercalados entre ellos. Posibilidad de generar cualquier tipo de blanco entre 2700 a 6500°K. Se puede cortar cada LED (15 mm). Se suministra con adhesivo 3M de doble cara. Protección IP33. 72W de consumo total el rollo de 5 mts.

5 mts flexible strip roll DUAL with 60 LEDS/m SMD 5050. 150 cold white and 150 warm white LEDS interleaved between them. Possibility to generate any kind of white between 2700 and 6500°. Can be cut every LED (15mm). Provided with 3M double side adhesive. IP33 protection. 5 mts roll total consume is 72W.



DESCRIPCIÓN DESCRIPTION	COLOR	PROTECCIÓN PROTECTION	ALIMENTACIÓN POWER SUPPLY	TIPO LED LED TYPE	CANT. mts Qty OF LED	FLUJO LUM. LUM. FLOW	CONSUMO CONSUME	
TF5BF+BC	Tira 5 mts		IP33	12V DC	5050	60 LEDS/m	1125lm/m	72W
CVRBF+BC	Controlador /Controller		IP33	12V DC	-	-	-	4W

Fuente de alimentación recomendada para un rollo de 5 mts LRS10024 (24V 100W). Para regular la tira led dual es preciso la instalación del equipo CVRBF+BC / Recommended power supply for a 5 mts roll: LRS10024 (24V 100W). To control the DUAL flexible strip the installation of the device CVRBF+BC is necessary

CONECTORES Y EMPALMES SIN SOLDADURA

CONNECTORS AND JUNCTIONS WITHOUT WELDING



SERIE ECO

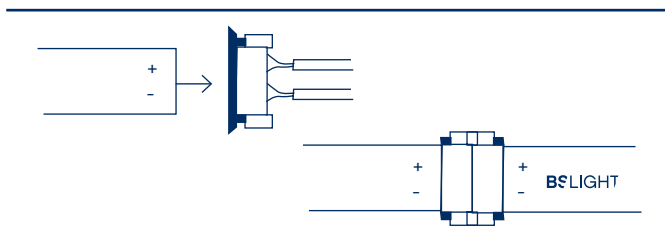

DESCRIPCIÓN / DESCRIPTION

CTFC	Conector alimentación TF5 monocolor / Power supply connector single-color TF5
ETFC	Empalme para TF5 monocolor / Junction for single-color TF5
CTFRGB	Conector alimentación para TF5 RGB / Power supply connector RGB TF5
ETFRGB	Empalme para TF5 RGB / Junction RGB TF5



SERIE PROF



DESCRIPCIÓN / DESCRIPTION

CTFC/2	Conector alimentación TF5 monocolor para tiras 8mm / Power supply connector single-color TF5 for 8mm strips
ETFC/2	Empalme para TF5 monocolor para tiras 8mm / Junction for single-color TF5 for 8mm strips
CTFC/2-10	Conector alimentación TF5 monocolor para tiras 10mm / Power supply connector single-color TF5 for 10mm strips
ETFC/2-10	Empalme para TF5 monocolor para tiras 10mm / Junction for single-color TF5 for 10mm strips
CTFRGB	Conector alimentación para TF5 RGB / Power supply connector RGB TF5
ETFRGB	Empalme para TF5 RGB / Junction for RGB TF5

TERMORRETRÁCTIL CON SILICONA

HEAT SHRINKING TUBE WITH SILICONE



Tubo termorretráctil con silicona interior para hacer estanca IP67 una conexión. Se suministra en tramos de 1 mt.

Heat shrinking tube with silicone inside to make it IP67 waterproof. The tubes are supplied in sections of 1 mt.



DESCRIPCIÓN / DESCRIPTION

XBDW-12.7-TR-1	Tubo termorretráctil 12,7mm - 1mts con silicona / Heat shrink tube 12,7mm - 1mt with silicone
----------------	---



MÓDULO 2 LEDS 2 LEDS MODULES



Módulos de 2 LEDS tipo 5050 ideales para rotulación y letras corpóreas. Se entregan cableados en kits de 20 piezas. Se fijan mediante cinta adhesiva o tornillos. Ideales para letras corpóreas o cajas de luz con un fondo de 8 a 18cm. Se pueden unir en serie un máximo de 50 Pcs.

Modules 2 LEDS 5050 for neon signs. Wire kits of 20 pieces included. The strip can be fixed with adhesive or screws. Ideal for neon signs or lighting boxes of 8 to 18 cm deep. Until 50 Pcs can be connected in serie.

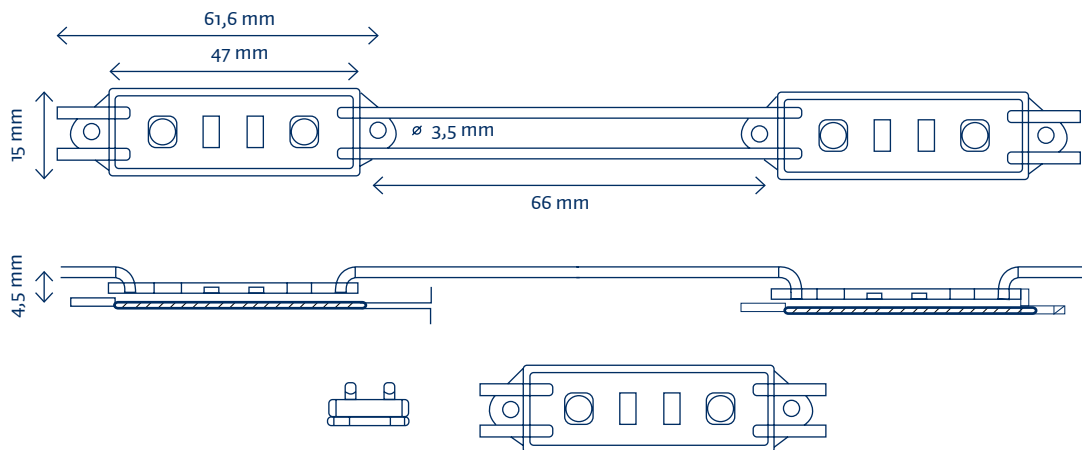

	COLOR COLOR	TEMPERATURA TEMPERATURE	PROTECCIÓN PROTECTION	ALIMENTACIÓN POWER SUPPLY	FLUJO LUM. LUM. FLOW	EFICIENCIA L. EFFICIENCY	ÁNGULO ANGLE	CONSUMO CONSUME
M2R		620-630nm	IP 65	12V DC	12,2lm	25,4lm/W	115°	0,48W
M2AM		512-528nm	IP 65	12V DC	9,6lm	20lm/W	115°	0,48W
M2AZ		463-475nm	IP 65	12V DC	6,4lm	13,3lm/W	115°	0,48W
M2V		584-594nm	IP 65	12V DC	24lm	50lm/W	115°	0,48W
M2BF		6000°K	IP 65	12V DC	32lm	66,7lm/W	115°	0,48W
M2BC		3000°K	IP 65	12V DC	32lm	66,7lm/W	115°	0,48W

Fuente de alimentación recomendada para 20 Pcs FT121,25 / Recommended power supply for 20 Pcs: FT121,25



MÓDULO 4 LEDS 4 LEDS MODULES



Módulos de 4 LEDS tipo 5050 ideales para rotulación y letras corpóreas. Se entregan cableados en kits de 20 piezas. Se fijan mediante cinta adhesiva o tornillos. Ideales para letras corpóreas o cajas de luz con un fondo de 6 a 18cm. Se pueden unir en serie un máximo de 20 Pcs.

Modules 4 LEDS 5050 for neon signs. Wire kits of 20 pieces included. The strip can be fixed with adhesive or screws. Ideal for neon signs or lighting boxes of 6 to 18 cm deep. Until 20 Pcs can be connected in serie.

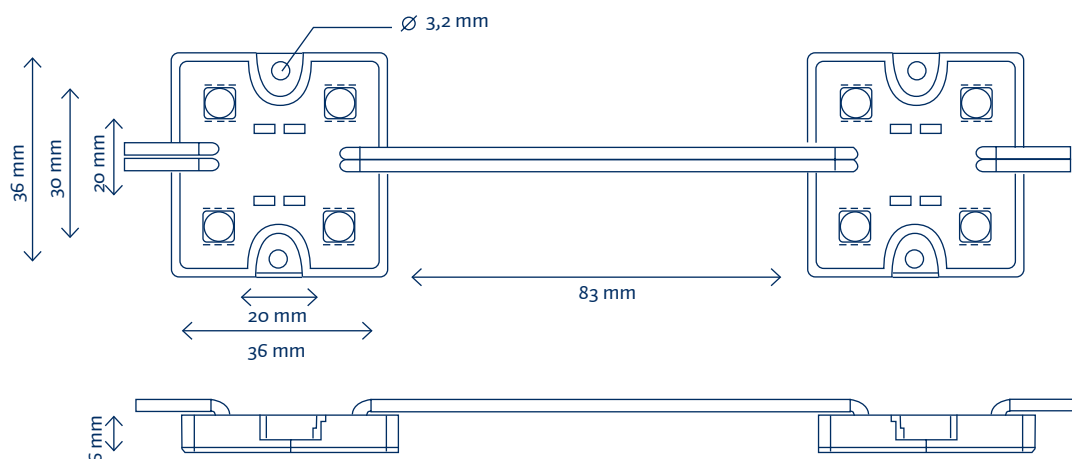

	COLOR COLOR	TEMPERATURA TEMPERATURE	PROTECCIÓN PROTECTION	ALIMENTACIÓN POWER SUPPLY	FLUJO LUM. LUM. FLOW	EFICIENCIA L. EFFICIENCY	ÁNGULO ANGLE	CONSUMO CONSUME
M4R		620-630nm	IP 65	12V DC	24,4lm	25,4lm/W	115°	0,96W
M4AM		512-528nm	IP 65	12V DC	19,20lm	20lm/W	115°	0,96W
M4AZ		463-475nm	IP 65	12V DC	12,8lm	13,3lm/W	115°	0,96W
M4V		584-594nm	IP 65	12V DC	48lm	50lm/W	115°	0,96W
M4BF		6000°K	IP 65	12V DC	64lm	66,7lm/W	115°	0,96W
M4BC		3000°K	IP 65	12V DC	64lm	66,7lm/W	115°	0,96W

Fuente de alimentación recomendada para 20Pcs LPV3512 / Recommended power supply for 20Pcs: LPV3512



MÓDULO 3 LEDS RGB

3 LEDS MODULES RGB



Módulos de 3 LEDS tipo 5050 ideales para rotulación y letras corpóreas. Se entregan cableados en kits de 20 piezas. Se fijan mediante cinta adhesiva o tornillos. Ideales para letras corpóreas o cajas de luz con un fondo de 6 a 16cm. Se pueden unir en serie un máximo de 50 Pcs.

Modules 3 LEDS 5050 for neon signs. Wire kits of 20 pieces included. The strip can be fixed with adhesive or screws. Ideal for neon signs or lighting boxes of 6 to 16 cm deep. Until 50 Pcs can be connected in serie.

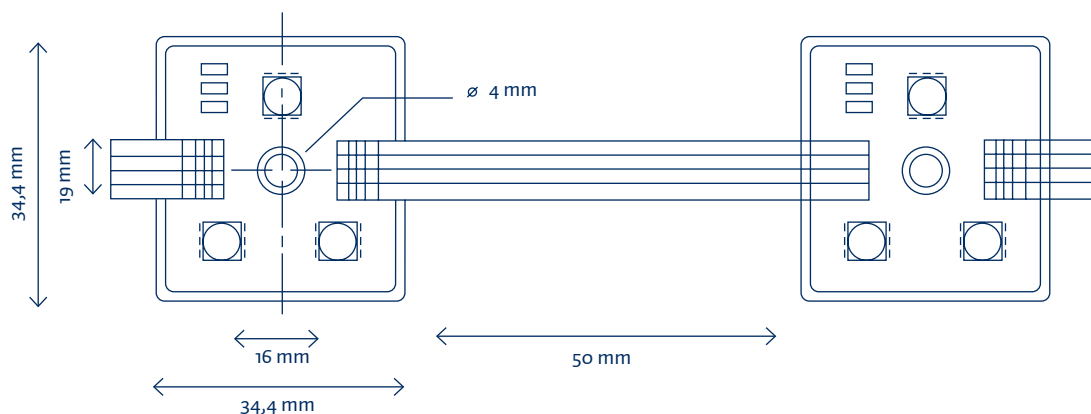

COLOR COLOR	TEMPERATURA TEMPERATURE	PROTECCIÓN PROTECTION	ALIMENTACIÓN POWER SUPPLY	FLUJO LUM. LUM. FLOW	ÁNGULO ANGLE	CONSUMO CONSUME
	620-630nm	IP 65	12V DC	10,5lm	115°	0,48W
M3RGB	584-594 nm	IP 65	12V DC	18,0lm	115°	0,48W
	463-475nm	IP 65	12V DC	10,5lm	115°	0,48W

Fuente de alimentación recomendada para 20Pcs LPV2012. Es necesario un controlador RGB PWM para el funcionamiento de los módulos /
Recommended power supply for 20Pcs: LPV2012. It is necessary to use a RGB PWM controller

¿Cómo escoger su tira led?

How to choose your Led strip?

Encuentre la tira led que mejor se adapte a sus necesidades siguiendo estos consejos y cuadro de características.

Find the LED strip that best suits your needs following these advices and box features.

1. Escoja su tira led en función de la potencia lumínica que necesita en cada caso según el recuadro. Para tiendas de ropa, zapatos, comestibles, etc, selecciones una tira RA95 para conseguir unos colores más reales de los productos.
- 2.- Escoja la protección de la tira. IP33 tira sin protección para uso interior. IP66 tira con silicona para uso interior. IP68 tira con triple silicona para uso exterior.
- 3.- Escoja el perfil adecuado a su instalación comprobando que el ancho interior del perfil sea superior a la tira seleccionada.
- 4.- Escoja la fuente de alimentación en función de la tensión y la potencia de la tira seleccionada y si la instalación será de interior o exterior. Seleccione una potencia un 20% superior a la potencia de la carga.
- 5.- En caso de utilizar tiras RGB o RGBW, seleccione el controlador que mejor se adapte a sus necesidades.

1. Choose your led strip light depending on the power required in each case according the image for clothing stores, shoes, food shops, etc, select a strip RA95 to achieve more real colors of the products.
- 2.- Choose the IP33 protection for indoor use. IP66 protection with silicone for indoor use. IP68 protection with triple silicone for outdoor use.
- 3.- Choose the appropriate profile for your installation checking that the inside width of this profile is greater than the selected strip.
- 4.- Choose the power supply depending on the voltage and power of the selected strip and also it depends on the indoor or outdoor installation. Select a power 20% higher than the power of the load.
- 5.- In case to use RGB or RGBW, choose the controller that best suits your needs.

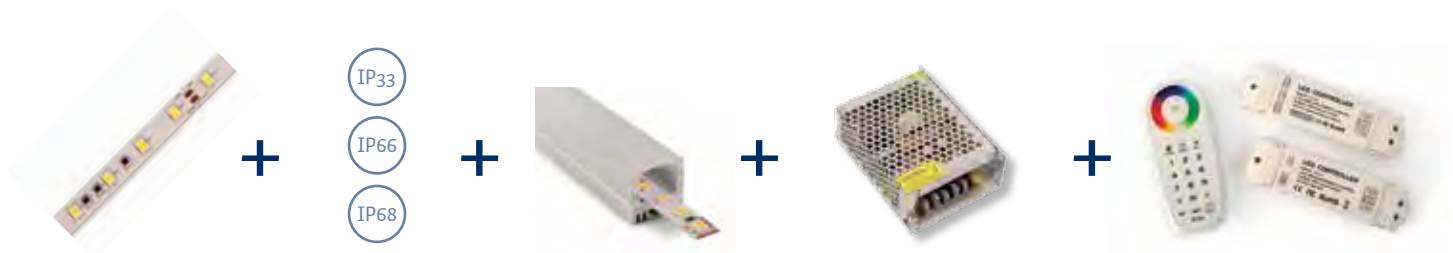

POTENCIA POWER	V V	LUMEN/M LUMEN/M	LED LED	LEDS/M LED/M	CRI CRI	PÁGINA PAGE	ANCHO TIRA (IP33) WIDTH STRIP	SERIE SERIE
4,8W/m	12V	390lm/m	3528	60leds/m	RA80	8	8mm	TF5-XX
7,2W/m	12V	540lm/m	5050	30leds/m	RA80	20	10mm	TF5-XX-AP
9,6W/m	24V	780lm/m	3528	120leds/m	RA80	14	8mm	TF5-XX-600
14,4W/m	24V	1170lm/m	5050	60leds/m	RA80	23	10mm	TF5-XX-AP-300
19,2W/m	24V	1560lm/m	3528	240leds/m	RA80	17	15mm	TF5-XX-1200
28,8W/m	24V	2280lm/m	5630	60leds/m	RA80	26	12mm	TF5-XX-HP-300
28,8W/m	24V	2250lm/m	2835	96leds/m	RA80	27	16mm	TF5-XX-SAP
12W/m	24V	850lm/m	2835	120leds/m	RA95	28	10mm	TF5-XX-RA95
28,4W/m	24V	2190lm/m	2835	182leds/m	RA95	30	10mm	TF5-XX-HP95

También disponibles tiras led especiales asimétricas, en formato 3D, directas a 230VAC, sistemas BS-Flexneon / LED strips also available in special asymmetrical 3D format, direct to 230VAC, systems BS-Flexneon

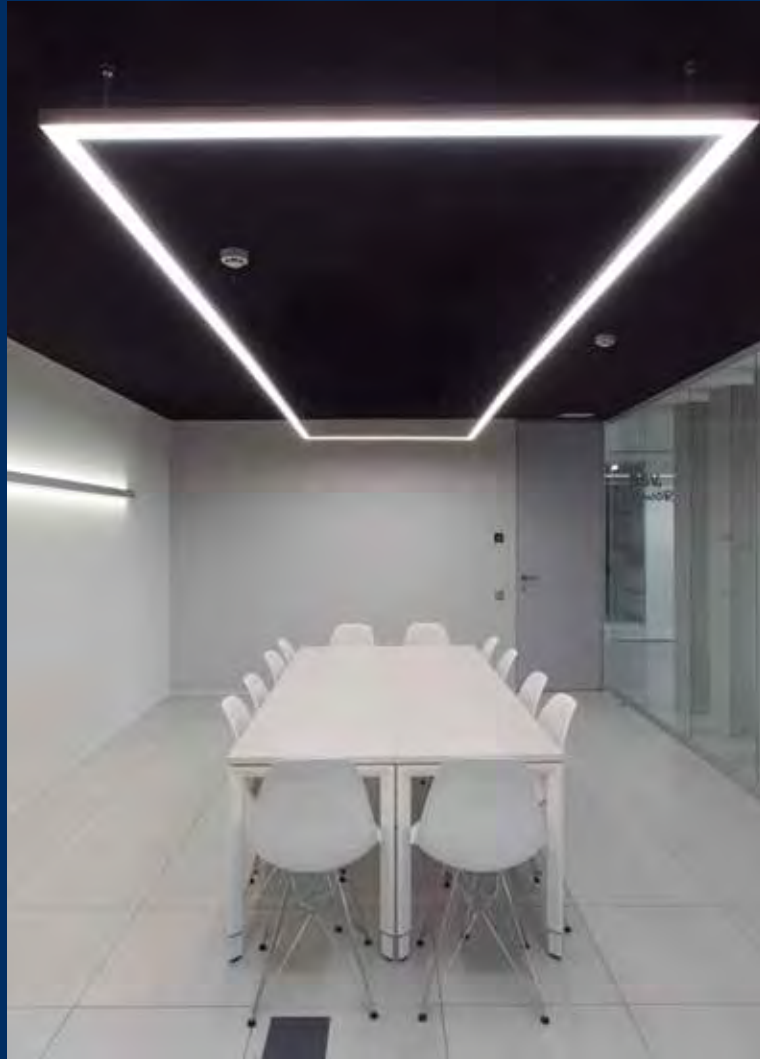

PERFILES Y ACCESORIOS

02

PROFILES AND ACCESSORIES

PERFIL ALUMINIO REDONDO

ROUND ALUMINUM PROFILE



46
47

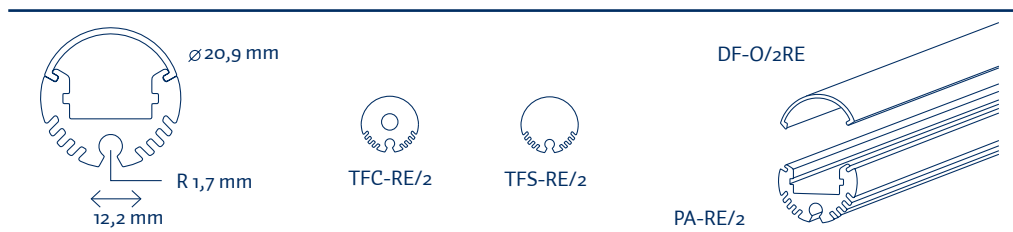

Perfil de aluminio anodizado redondo con difusor ideal para tiras LED rígidas o flexibles. Tanto los perfiles como los difusores se entregan en tramos de 2 mts.

The round aluminum anodized profile is ideal for rigid or flexible LED strip. Diffusers and profiles are supplied 2 mts/pcs.

DESCRIPCIÓN / DESCRIPTION

PA-RE/2	Perfil aluminio redondo / Round aluminium profile
TFS-RE/2	Tapón final para perfil redondo / End cap for round aluminum profile
TFC-RE/2	Tapón final para perfil redondo c/agujero / End cap with hole for round profile
DF-O/2RE	Difusor opal para perfil PA-RE/2 / Opal diffuser for PA-RE/2 profile

PERFIL ALUMINIO ESQUINERA

CORNER ALUMINUM PROFILE

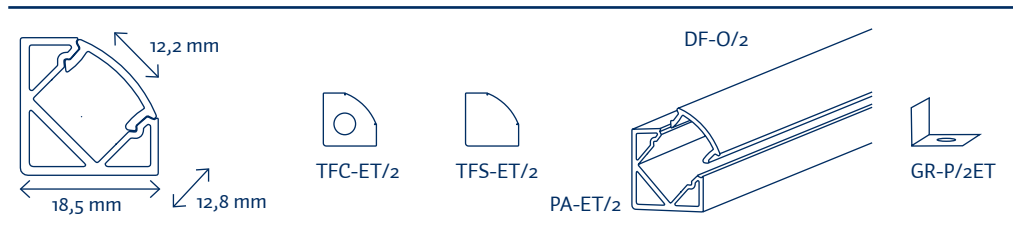

Perfil de aluminio anodizado de superficie esquinera con difusor ideal para tiras LED rígidas o flexibles. Tanto los perfiles como los difusores se entregan en tramos de 2 mts.

The corner aluminum anodized profile is ideal for rigid or flexible LED strip. Diffusers and profiles are supplied 2 mts/pcs.

DESCRIPCIÓN / DESCRIPTION

PA-ET/2	Perfil aluminio esquinera / Corner profile aluminum
TFS-ET/2	Tapón final para perfil esquinera ET / End cap for corner profile ET
TFC-ET/2	Tapón final para perfil esquinera ET c/agujero / End cap with hole for corner profile ET
DF-T/2	Difusor transparente perfil PA-SM, SE, EM, EE y ET / Transparent diffuser profile PA-SM, SE, EM, EE and ET
DF-ST/2	Difusor semi-transparente perfil PA-SM, SE, EM, EE Y ET / Semi-transparent diffuser profile PA-SM, SE, EM, EE and ET
DF-O/2	Difusor opal perfil PA-SM, SE, EM, EE y ET / Opal diffuser profiles PA-SM, SE, EM, EE and ET
DFO60-T/2	Difusor con óptica perfil PA-SM, SE, EM, EE Y ET / Optical diffuser profile PA-SM, SE, EM, EE and ET
GR-P/2ET	Grapa sujeción para perfil esquinera PA-ET / Clip for corner profile PA-ET

PERFIL ALUMINIO “ESTANCO” “WATERPROOF” ALUMINUM PROFILE

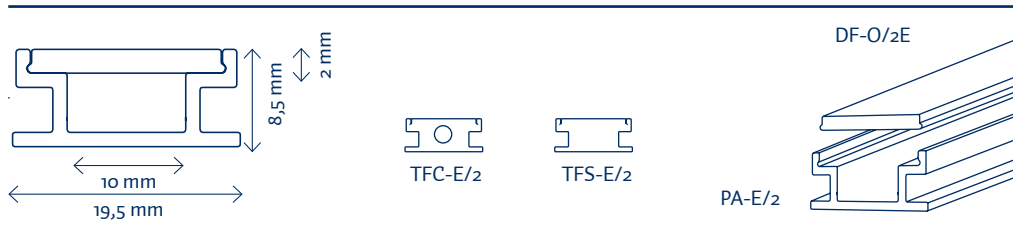

Perfil de aluminio anodizado estanco con difusor ideal para tiras LED rígidas o flexibles. Tanto los perfiles como los difusores se entregan en tramos de 2 mts. El perfil se convierte en estanco al utilizar la resina.

Anodized aluminum waterproof profile, with diffuser is ideal for rigid or flexible LED strip. Diffusers and profiles are supplied 2 mts/pcs.pieces. The profile becomes tight when using the resin.

DESCRIPCIÓN / DESCRIPTION

PA-E/2	Perfil aluminio empotrar estanco / Aluminum waterproof recessed profile
TFS-E/2	Tapón final para perfil estanco E / End cap for waterproof E profile
TFC-E/2	Tapón final para perfil estanco E c/agujero / End cap with hole for waterproof E profile
DF-O/2E	Difusor opal grueso para perfil PA-E / Opal thick diffuser for PA-E profile
5050UV	Resina 1kg y endurecedor 0,4kg / 1kg and 0.4kg resin hardener

PERFIL ALUMINIO CON CANAL ALUMINUM PROFILE WITH GUIDE

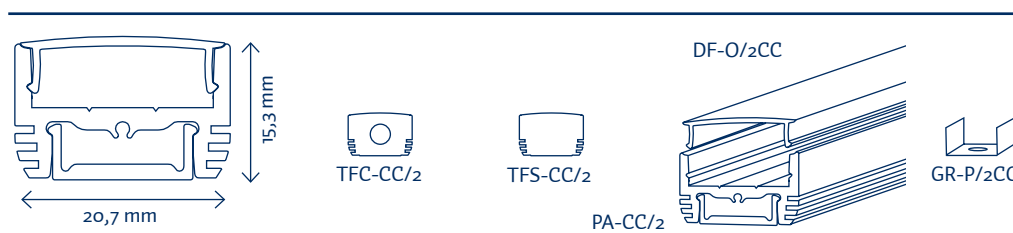

Perfil de aluminio anodizado con canal con difusor ideal para tiras LED rígidas o flexibles. Tanto los perfiles como los difusores se entregan en tramos de 2 mts.

Anodized aluminum profile with guide and diffuser, ideal for rigid or flexible LED strip. Diffusers and profiles are supplied 2 mts/pcs.

DESCRIPCIÓN / DESCRIPTION

PA-CC/2	Perfil aluminio con canal / Aluminum profile with guide
DF-O/2CC	Difusor opal para perfil con canal / Opal diffuser for profile with guide
DF-T/2CC	Difusor transparente para perfil con canal / Transparent diffuser for profile with guide
TFS-CC/2	Tapón final ciego para perfil con canal / End cap for profile with guide
TFC-CC/2	Tapón final con agujero para perfil con canal / End cap with hole for profile with guide
GR-P/2CC	Grapa para perfil con canal / Clip for profile with guide

PERFIL ALUMINIO ESQUINERA CUADRADO

SQUARE CORNER ALUMINUM PROFILE

48
49

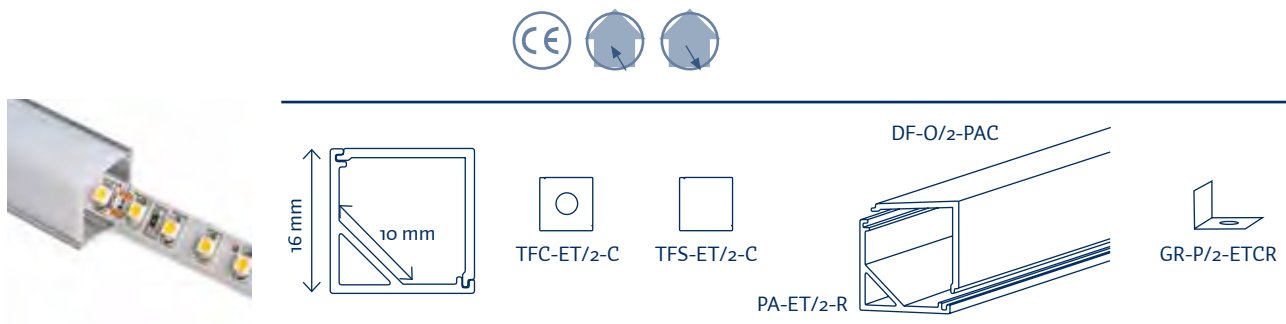

Perfil de aluminio anodizado de superficie esquinera con difusor cuadrado ideal para tiras LED rígidas o flexibles. Tanto los perfiles como los difusores se entregan en tramos de 2 mts.

Square aluminum profile is ideal for rigid or flexible LED strip. Diffusers and profiles are supplied 2 mts/pcs.

DESCRIPCIÓN / DESCRIPTION

PA-ET/2-R	Perfil aluminio esquinera cuadrado / Aluminum square corner profile
DF-O/2-PAC	Difusor opal perfil esquinera cuadrado / Opal diffuser for square corner profile
TFS-ET/2C	Tapón final para perfil esquinera cuadrado / End cap for square corner profile
TFC-ET/2C	Tapón final para perfil esquinera cuadrado c/agujero / End cap with hole for square corner profile
GR-P/2-ETCR	Grapa perfil esquinera cuadrado-redondo / Profile's Clip for square or round profile

PERFIL ALUMINIO ESQUINERA REDONDO

ROUND CORNER ALUMINUM PROFILE

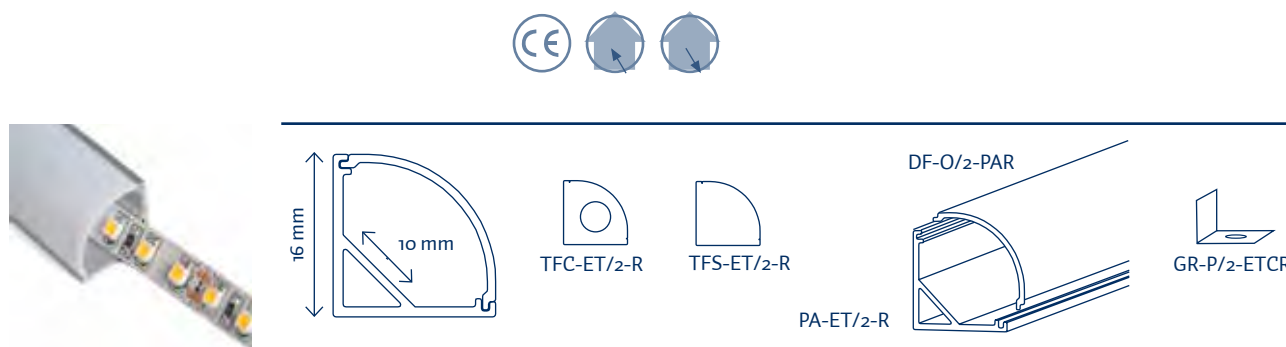

Perfil de aluminio anodizado de superficie esquinera con difusor redondo ideal para tiras LED rígidas o flexibles. Tanto los perfiles como los difusores se entregan en tramos de 2 mts.

Round aluminum profile is ideal for rigid or flexible LED strip. Diffusers and profiles are supplied 2 mts/pcs.

DESCRIPCIÓN / DESCRIPTION

PA-ET/2-R	Perfil aluminio esquinera redondo / Aluminum corner round profile
DF-O/2-PAR	Difusor opal perfil esquinera redondo / Opal diffuser for round corner profile
TFS-ET/2R	Tapón final para perfil esquinera redondo / End cap for round corner profile
TFC-ET/2R	Tapón final para perfil esquinera redondo c/agujero / End cap with hole for round corner profile
GR-P/2-ETCR	Grapa perfil esquinera cuadrado-redondo / Clip for round or square corner profile

PERFIL ALUMINIO EMPOTRAR MINI MINI RECESSED ALUMINUM PROFILE

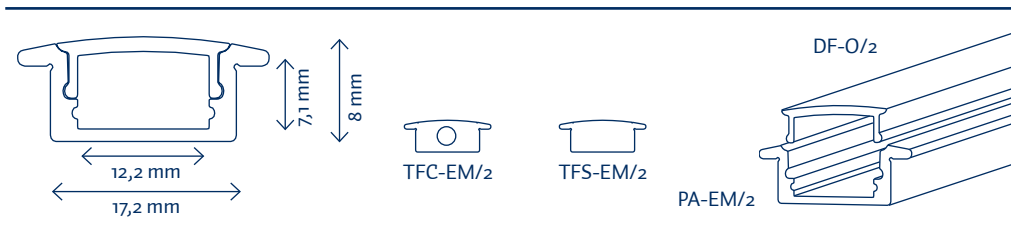

Perfil de aluminio anodizado para empotrar mini ideal para tiras LED rígidas o flexibles. Tanto los perfiles como los difusores se entregan en tramos de 2 mts.

The mini Anodized aluminum recessed profile is ideal for rigid or flexible LED strip. Diffusers and profiles are supplied 2 mts/pcs.

DESCRIPCIÓN / DESCRIPTION

PA-EM/2	Perfil aluminio empotrar mini / Mini aluminum recessed profile
TFS-EM/2	Tapón final para perfil empotrar mini / End cap for mini recessed profile
TFC-EM/2	Tapón final para perfil empotrar mini con agujero / End cap for mini recessed profile with hole
DF-T/2	Difusor transparente perfil PA-SM, SE, EM, EE y ET / Transparent diffuser profile PA-SM, SE, EM, EE y ET
DF-ST/2	Difusor semi-transparente perfil PA-SM, SE, EM, EE Y ET / Semi-transparent diffuser profile PA-SM, SE, EM, EE and ET
DF-O/2	Difusor opal perfil PA-SM, SE, EM, EE y ET / Opal diffuser for profile PA-SM, SE, EM, EE y ET
DFO60-T/2	Difusor con óptica perfil PA-SM, SE, EM, EE Y ET / Optical diffuser profile PA-SM, SE, EM, EE and ET

PERFIL ALUMINIO SUPERFICIE MINI MINI SURFACE ALUMINUM PROFILE

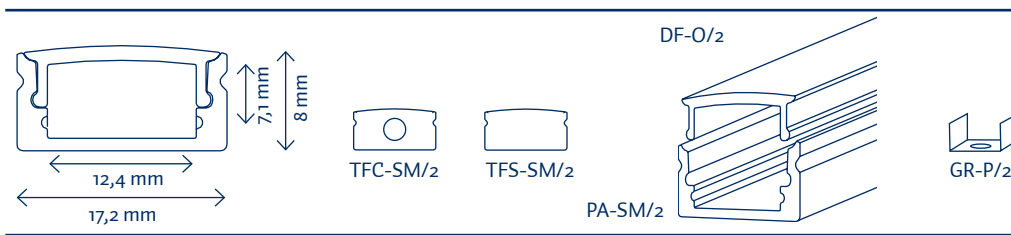

Perfil de aluminio anodizado mini ideal para tiras LED rígidas o flexibles. Tanto los perfiles como los difusores se entregan en tramos de 2 mts.

Corner round the mini Anodized aluminum recessed profile is ideal for rigid or flexible LED strip. Diffusers and profiles are supplied 2 mts/pcs.

DESCRIPCIÓN / DESCRIPTION

PA-SM/2	Perfil aluminio superficie mini / Mini aluminum surface profile
TFS-SM/2	Tapón final para perfil superficie mini / End cap for mini surface profile
TFC-SM/2	Tapón final para perfil superficie mini c/agujero / End cap for minisurface profile with hole
DF-T/2	Difusor transparente perfil PA-SM, SE, EM, EE y ET / Transparent diffuser profile PA-SM, SE, EM, EE y ET
DF-ST/2	Difusor semi-transparente perfil PA-SM, SE, EM, EE Y ET / Semi-transparent diffuser profile PA-SM, SE, EM, EE and ET
DF-O/2	Difusor opal perfil PA-SM, SE, EM, EE y ET / Opal diffuser profile PA-SM, SE, EM, EE y ET
DFO60-T/2	Difusor con óptica perfil PA-SM, SE, EM, EE Y ET / Optical diffuser profile PA-SM, SE, EM, EE and ET
GR-P-2	Grapa sujeción perfil para PA-SM/2 / Clip profile PA-SM/2

PERFIL ALUMINIO EMPOTRAR ESTÁNDAR

STANDARD RECESSED ALUMINUM PROFILE



50
51

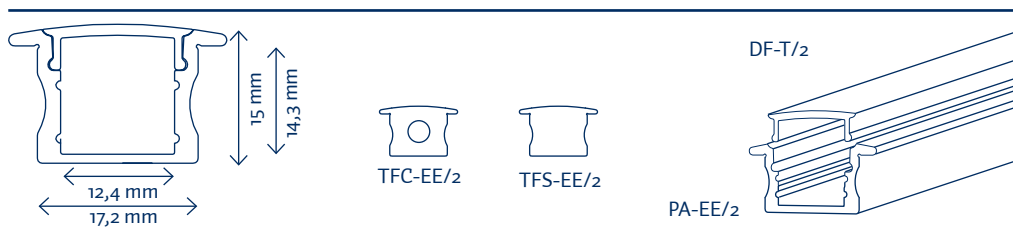

Perfil de aluminio anodizado para empotrar ideal para tiras led rígidas o flexibles. Tanto los perfiles como los difusores se entregan en tramos de 2 mts.

Anodized aluminum recessed profile, ideal for flexible or rigid strips. Diffusers and profiles are supplied 2 mts/pcs. pieces.

DESCRIPCIÓN / DESCRIPTION

PA-EE/2	Perfil aluminio empotrar estándar / Aluminum standard recessed profile
TFS-EE/2	Tapón final para perfil empotrar estándar / End cap for standard recessed profile
TFC-EE/2	Tapón final para perfil empotrar estándar c/agujero / End cap with hole for standard recessed profile
DF-T/2	Difusor transparente perfil PA-SM, SE, EM, EE y ET / Transparent diffuser for profile PA-SM, SE, EM, EE and ET
DF-ST/2	Difusor semi-transparente perfil PA-SM, SE, EM, EE Y ET / Semi-transparent diffuser profile PA-SM, SE, EM, EE and ET
DF-O/2	Difusor opal perfil PA-SM, SE, EM, EE y ET / Opal diffusotr for profiles PA-SM, SE, EM, EE y ET
DFO60-T/2	Difusor con óptica perfil PA-SM, SE, EM, EE Y ET / Optical diffuser profile PA-SM, SE, EM, EE and ET

PERFIL ALUMINIO SUPERFÍCIE ESTÁNDAR

STANDARD ALUMINUM PROFILE

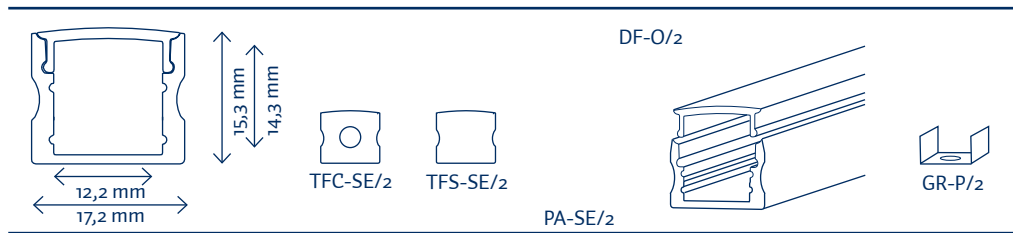

Perfil de aluminio anodizado de superficie ideal para tiras led rígidas o flexibles. Tanto los perfiles como los difusores se entregan en tramos de 2 mts.

Anodized aluminum surface profile, ideal for flexible or rigid strips. Diffusers and profiles are supplied 2 mts/pcs.

DESCRIPCIÓN / DESCRIPTION

PA-SE/2	Perfil aluminio superficie estándar / Aluminum standard surface profile
TFS-SE/2	Tapón final para perfil estándar / End cap for standard profile
TFC-SE/2	Tapón final para perfil estándar c/agujero / End cap with hole for standard profile
DF-T/2	Difusor transparente perfil PA-SM, SE, EM, EE y ET / Transparent diffuser for profile PA-SM, SE, EM, EE and ET
DF-ST/2	Difusor semi-transparente perfil PA-SM, SE, EM, EE Y ET / Semi-transparent diffuser profile PA-SM, SE, EM, EE and ET
DF-O/2	Difusor opal perfil PA-SM, SE, EM, EE y ET / Opal diffusotr for profiles PA-SM, SE, EM, EE y ET
DFO60-T/2	Difusor con óptica perfil PA-SM, SE, EM, EE Y ET / Optical diffuser profile PA-SM, SE, EM, EE and ET
GR-P/2	Grapa sujeción perfil para PA-SE/2 / Clip for PA-SE/2 profile

PERFIL ALUMINIO 16MM CON ÓPTICA

16MM ALUMINUM PROFILE WITH OPTIC DIFFUSER

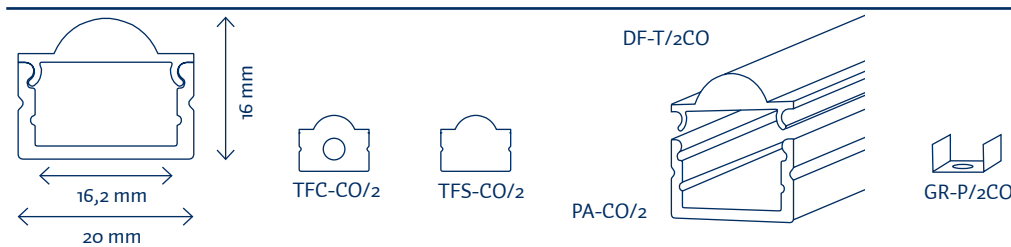

Perfil de aluminio anodizado de 16mm de interior con difusor en óptica 60° ideal para tiras LED rígidas o flexibles. Tanto los perfiles como los difusores se entregan en tramos de 2 mts.

The 16mm anodized aluminum profile with optic diffuser 60° is ideal for rigid or flexible LED strip. Diffusers and profiles are supplied 2 mts/pcs.

DESCRIPCIÓN / DESCRIPTION

PA-CO/2	Perfil aluminio tipo 16mm / Aluminum profile type 16mm
DF-T/2CO	Difusor transparente con óptica 60° / 60° optic transparent diffuser
TFS-CO/2	Tapón final ciego / End cap
TFC-CO/2	Tapón final con agujero / End cap with hole
GR-P/2CO	Grapa perfil CO/2 / CO/2 profile's clip

PERFIL ALUMINIO 16 MM REDONDO

16 MM ROUND ALUMINUM PROFILE

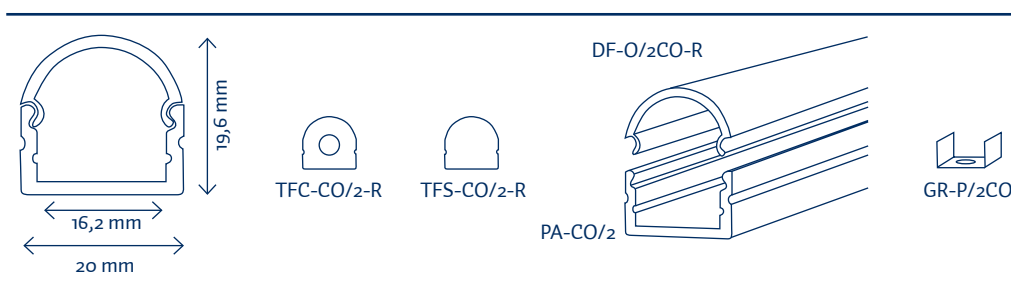

Perfil de aluminio anodizado de 16mm de interior con difusor redondo alto ideal para tiras LED rígidas o flexibles. Tanto los perfiles como los difusores se entregan en tramos de 2 mts.

The 16mm anodized aluminum profile with round diffuser is ideal for rigid or flexible LED strip. Diffusers and profiles are supplied 2 mts/pcs.

DESCRIPCIÓN / DESCRIPTION

PA-CO/2	Perfil aluminio tipo 16mm / Aluminum profile type 16mm
DF-O/2CO-R	Difusor opal mate redondo perfil CO/2 / Matt opal round diffuser for CO/2 profile
TFS-CO/2-R	Tapón final ciego / End cap
TFC-CO/2-R	Tapón final con agujero / End cap with hole
GR-P/2CO	Grapa perfil CO/2 / CO/2 clip profile

PERFIL ALUMINIO 16MM CUADRADO

16 MM SQUARE ALUMINUM PROFILE



52
53

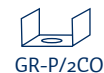
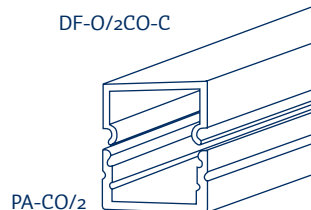
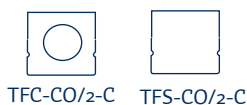
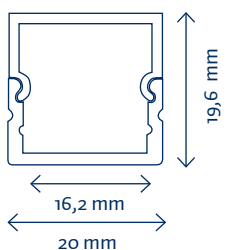

Perfil de aluminio anodizado de 16mm de interior difusor cuadrado alto ideal para tiras LED rígidas o flexibles. Tanto los perfiles como los difusores se entregan en tramos de 2 mts.

Anodized aluminum profile of 16mm surface, with Square diffuser for rigid or flexible LED strip. Diffusers and profiles are supplied 2 mts/pcs.

DESCRIPCIÓN / DESCRIPTION

PA-CO/2	Perfil aluminio con óptica 16mm / Aluminum profile with optic lens 16mm
DF-O/2CO-C	Difusor opal mate cuadrado perfil CO/2 / Matt, opal, square diffuser CO/2 profile
TFS-CO/2-C	Tapón final ciego para CO/2 cuadrado / End cap for square CO/2 profile
TFC-CO/2-C	Tapón final con agujero para CO/2 cuadrado / End cap with hole for square CO/2 profile
GR-P-2CO	Grapa perfil CO/2 / CO/2 clip profile

PERFIL ALUMINIO ELH

ELH ALUMINUM PROFILE

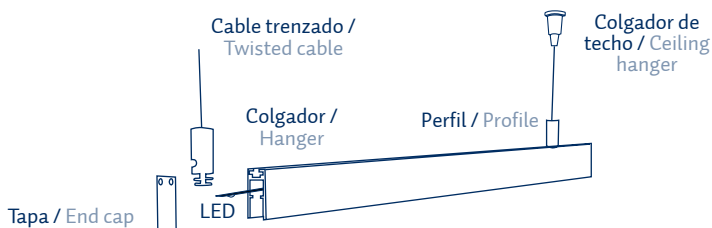
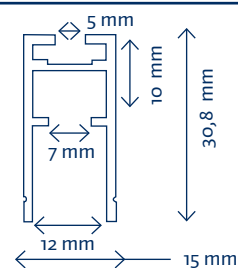

Perfil de aluminio serie ELH. Los perfiles se entregan en tramos de 3m.

ELH aluminium profile. Profiles are supplied 3 mts/pcs.

DESCRIPCIÓN / DESCRIPTION

PA-ELH	Perfil aluminio para estantes luminosos ELH / Aluminum profile for ELH shelf lighting
TSA7	Tapón final para perfil PA-ELH / End cap for PA-ELH profile
C-ELH	Colgador para perfil ELH / ELH profile's hanger
GP-ELH	Grapa pared para colgador ELH / Wall-clip for ELH hanger
CA-ELH	Cable de acero para colgador ELH / Iron cable for ELH hanger
E-ELH	Escuadra para ELH / Flat L-bracket for ELH

PERFIL ALUMINIO EMPOTRAR 31MM

RECESSED ALUMINUM PROFILE 31MM

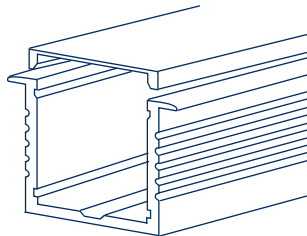
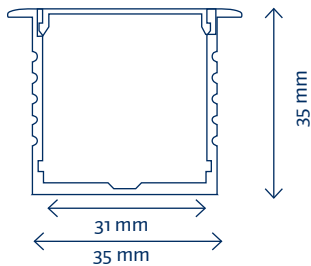

DIFUSOR



TAPA FINAL



GR-P/M



Perfil de aluminio anodizado de empotrar ancho 31mm para tiras LED rígidas o flexibles. Tanto los perfiles como los difusores se entregan en tramos de 2 mts.

Anodized aluminum recessed profile 31mm, ideal for flexible or rigid strip. Diffusers and profiles are supplied 2 mts/pcs.

DESCRIPCIÓN / DESCRIPTION

PA-AA/3	Perfil aluminio empotrar ancho 31mm / Aluminum recessed profile 31mm
DF-O/3AA	Difusor opal para perfil PA-AA/2 / Opal difusor for profiles PA-AA/2
TFS-AA/3	Tapón final para perfil ancho 31mm / End cap for profile 31mm
TFC-AA/3	Tapón final para perfil ancho 31mm c/ agujero / End cap with hole for profile 31mm
GR-EAD/2	Grapa para techo hueco
GR-P/M	Grapa con muelle para techo hueco

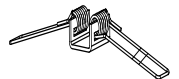

PERFIL ALUMINIO SUPERFICIE 31MM

SURFACE ALUMINUM PROFILE 31MM

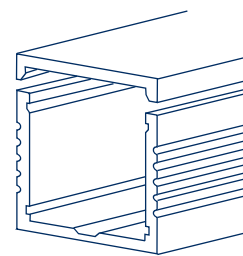
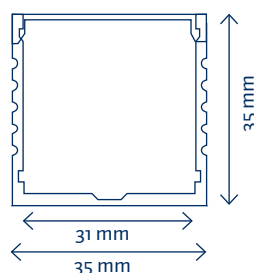

Perfil de aluminio anodizado de superficie ancho 31mm para tiras LED rígidas o flexibles. Tanto los perfiles como los difusores se entregan en tramos de 2 mts

Anodized aluminum surface profile 31mm, ideal for flexible or rigid strip. Diffusers and profiles are supplied 2 mts/pcs.

DESCRIPCIÓN / DESCRIPTION

PA-AAS/3	Perfil aluminio superficie ancho 31mm / Aluminum surface profile 31mm
DF-O/3AA	Difusor opal para perfil PA-AAS/2 / Opal difusor for profiles PA-AAS/2
TFS-AAS/3	Tapón final para perfil ancho 31mm / End cap for profile 31mm
TFC-AAS/3	Tapón final para perfil ancho 31mm c/ agujero / End cap with hole for profile 31mm

PERFIL DE ALUMINIO SUPERFICIE ALTA DENSIDAD 12,2MM

SURFACE HIGH DENSITY ALUMINUM PROFILE 12,2MM

54
55

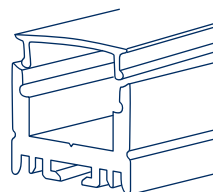
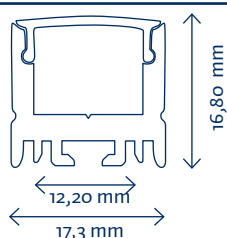

Perfil de aluminio anodizado de superficie alta densidad y ancho interior 12,2mm ideal para tiras LED rígidas o flexibles. Tanto los perfiles como los difusores se entregan en tramos de 2m.

Anodized aluminum surface high density 12,2mm, ideal for flexible or rigid strip. Diffusers and profiles are supplied 2 mts/pcs.

DESCRIPCIÓN / DESCRIPTION

PA-AD18/2	Perfil aluminio superficie alta densidad 12,2mm / Aluminum surface profile high density 12,2mm
DF-O/2	Difusor opal perfil PA-SM, SE, EM, EE, ET, AD18/2 y ZR / Opal diffuser profiles PA-SM, SE, EM, EE, ET, AD18/2 and ZR
DF-T/2	Difusor transparente perfil PA-SM, SE, EM, EE y ET / Transparent diffuser for profile PA-SM, SE, EM, EE and ET
DF-ST/2	Difusor semi-transparente perfil PA-SM, SE, EM, EE y ET / Semi-transparent diffuser for profiles PA-SM, SE, EM, EE y ET
DFO60-T/2	Difusor con óptica perfil PA-SM, SE, EM, EE Y ET / Optical diffuser profile PA-SM, SE, EM, EE and ET
TFS-AD18/2	Tapón final para perfil AD18 / End cap for profile AD18
TFC-AD18/2	Tapón final para perfil AD18 c/agujero / End cap with hole for profile AD18
GR-AD18/2	Grapa sujeción para perfil PA-AD18/2 / Clip for profile PA-AD18/2

PERFIL DE ALUMINIO SUPERFICIE ALTA DENSIDAD 20,2MM

SURFACE HIGH DENSITY ALUMINUM PROFILE 20,2MM

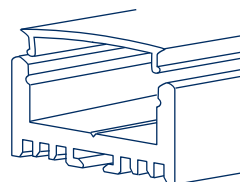
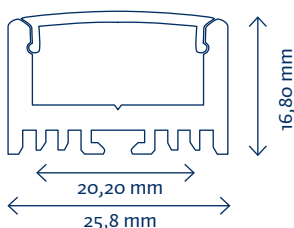

Perfil de aluminio anodizado de superficie alta densidad y ancho interior 20,2mm ideal para tiras LED rígidas o flexibles. Tanto los perfiles como los difusores se entregan en tramos de 2mts.

Anodized aluminum surface high density 20,2mm, ideal for flexible or rigid strip. Diffusers and profiles are supplied 2 mts/pcs.

DESCRIPCIÓN / DESCRIPTION

PA-AD26/2	Perfil aluminio superficie alta densidad 20,2mm / Aluminum surface profile high density 20,2mm
DF-O/2-AD26	Difusor opal perfil PA-AD26/2 / Opal diffuser profiles PA-AD26/2
TFS-AD26/2	Tapón final para perfil AD26 / End cap for profile AD26
TFC-AD26/2	Tapón final para perfil AD26 c/agujero / End cap with hole for profile AD26

PERFIL DE ALUMINIO SUPERFICIE ALTA DENSIDAD 43,3MM BAJO

SURFACE HIGH DENSITY ALUMINUM PROFILE 43,3MM LOW

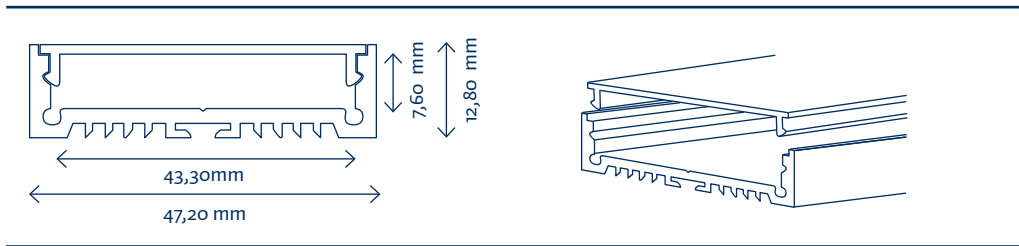

Perfil de aluminio anodizado de superficie alta densidad y ancho interior 43,3mm bajo ideal para tiras LED rígidas o flexibles. Tanto los perfiles como los difusores se entregan en tramos de 2m.

Anodized aluminum surface high density 43,3mm low ideal for flexible or rigid strip. Diffusers and profiles are supplied 2 mts/pcs.

DESCRIPCIÓN / DESCRIPTION

PA-ADA18/2	Perfil aluminio superficie alta densidad 43,3mm bajo / Aluminum surface profile high density 43,3mm low
DF-O/2-ADA	Difusor opal perfil PA-ADA18-ADA24 y EAD / Opal diffuser profiles PA-ADA18-ADA24 and EAD
TFS-ADA18/2	Tapón final para perfil ADA18 / End cap for profile ADA18

PERFIL DE ALUMINIO SUPERFICIE ALTA DENSIDAD 43,3MM STANDAR

SURFACE HIGH DENSITY ALUMINUM PROFILE 43,3MM STANDARD

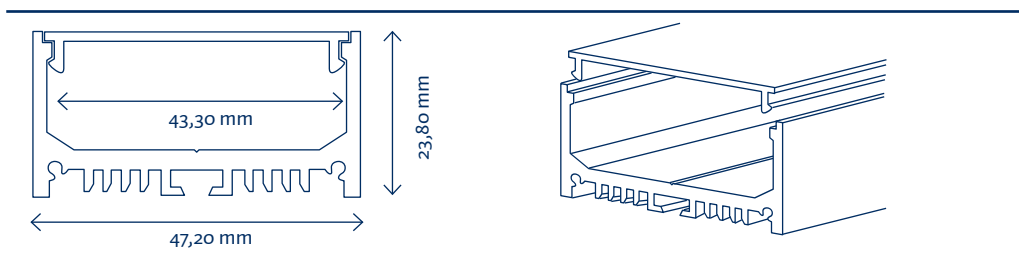

Perfil de aluminio anodizado de superficie alta densidad y ancho interior 43,3mm standar ideal para tiras LED rígidas o flexibles. Tanto los perfiles como los difusores se entregan en tramos de 2m.

Anodized aluminum surface high density 43,3mm standard ideal for flexible or rigid strip. Diffusers and profiles are supplied 2 mts/pcs.

DESCRIPCIÓN / DESCRIPTION

PA-ADA24/2	Perfil aluminio superficie alta densidad 43,3mm standar / Aluminum standar surface profile high density 43,3mm
DF-O/2-ADA	Difusor opal perfil PA-ADA18-ADA24 y EAD / Opal diffuser profiles PA-ADA18-ADA24 and EAD
TFS-ADA24/2	Tapón final para perfil ADA24 / End cap for profile ADA24

PERFIL DE ALUMINIO EMPOTRAR ALTA DENSIDAD 43,3MM

RECESSED HIGH DENSITY ALUMINUM PROFILE

43,3MM

56
57

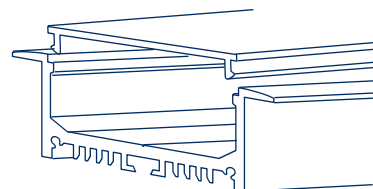
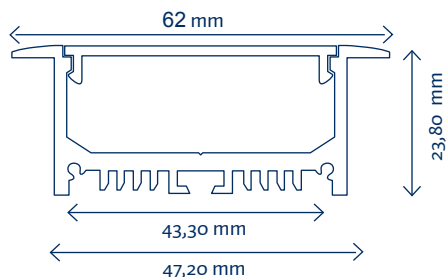

Perfil de aluminio anodizado de empotrar alta densidad y ancho 43,3mm ideal para tiras LED rígidas o flexibles. Tanto los perfiles como los difusores se entregan en tramos de 2m.

Anodized aluminum recessed high density 43,3mm , ideal for flexible or rigid strip. Diffusers and profiles are supplied 2 mts/pcs.

DESCRIPCIÓN / DESCRIPTION

PA-EAD/2	Perfil aluminio empotrar alta densidad 43,3mm/ Aluminum recessed profile high density 43,3mm
DF-O/2-ADA	Difusor opal perfil PA-ADA18-ADA24 y EAD / Opal diffuser profiles PA-ADA18-ADA24 and EAD
TFS-EAD/2	Tapón final para perfil EAD / End cap for profile EAD
GR-EAD/2	Grapa sujeción para perfil EAD / Clip for profile EAD
GR-P/M	Grapa con muelle para techo hueco



PERFIL DE ALUMINIO PARA PELDAÑOS

STEPS ALUMINUM PROFILE

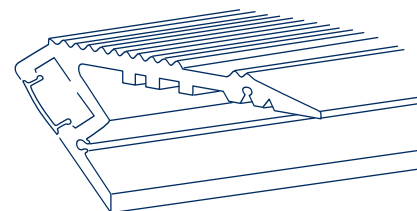
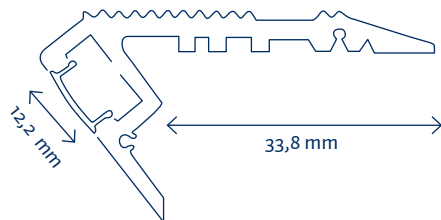

Perfil de aluminio anodizado para peldaños, ideal para tiras LED rígidas o flexibles. Tanto los perfiles como los difusores se entregan en tramos de 2m.

Anodized aluminum for steps ideal for flexible or rigid strip. Diffusers and profiles are supplied 2 mts/pcs.

DESCRIPCIÓN / DESCRIPTION

PA-PP/2	Perfil aluminio para peldaños / Aluminum profile for steps
DF-O/2-PP	Difusor opal perfil PA-PP / Opal diffuser profiles PA-PP
TFS-PP/2	Tapón final para perfil PP/ End cap for profile PP

PERFIL DE ALUMINIO ESQUINERO 30MM

CORNER ALUMINUM PROFILE 30MM

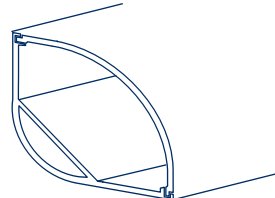
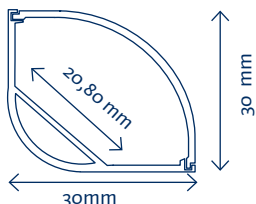

Perfil de aluminio anodizado redondo de 30mm, ideal para tiras LED rígidas o flexibles. Tanto los perfiles como los difusores se entregan en tramos de 2m.

Anodized aluminum corner profile 30mm ideal for flexible or rigid strip. Diffusers and profiles are supplied 2 mts/pcs.

DESCRIPCIÓN / DESCRIPTION

PA-LS42/2	Perfil aluminio esquinero 30mm / Aluminum corner profile 30mm
DF-O/2-LS42	Difusor opal perfil PA-LS42 / Opal diffuser profiles PA-LS42
TFS-LS42/2	Tapón final para perfil LS42 / End cap for profile LS42
TFC-LS42/2	Tapón final para perfil LS42 c/agujero / End cap with hole for profile LS42

PERFIL DE ALUMINIO ESQUINERO 55MM

CORNER ALUMINUM PROFILE 55MM

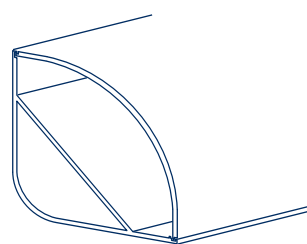
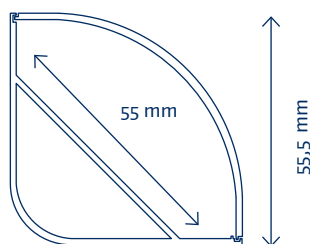
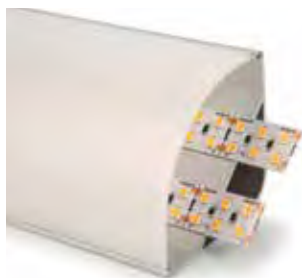

Perfil de aluminio anodizado redondo de 55mm, ideal para tiras LED rígidas o flexibles. Tanto los perfiles como los difusores se entregan en tramos de 2m.

Anodized aluminum corner profile 55mm ideal for flexible or rigid strip. Diffusers and profiles are supplied 2 mts/pcs.

DESCRIPCIÓN / DESCRIPTION

PA-LS77/2	Perfil aluminio esquinero 55mm / Aluminum corner profile 55mm
DF-O/2-LS77	Difusor opal perfil PA-LS77 / Opal diffuser profiles PA-LS77
TFS-LS77/2	Tapón final para perfil LS77 / End cap for profile LS77
TFC-LS77/2	Tapón final para perfil LS77 c/agujero / End cap with hole for profile LS77

PERFIL DE ALUMINIO FORMA Y Y ALUMINUM PROFILE



58
59

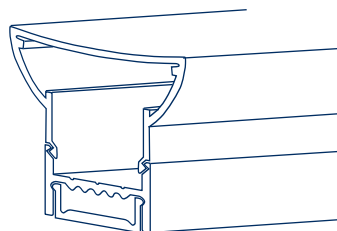
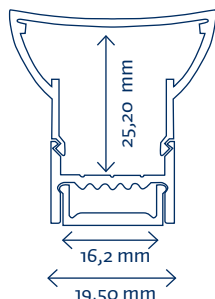

Perfil de aluminio anodizado forma Y, ideal para tiras LED rígidas o flexibles. Tanto los perfiles como los difusores se entregan en tramos de 2m.

Anodized aluminum shape Y ideal for flexible or rigid strip. Diffusers and profiles are supplied 2 mts/pcs.

DESCRIPCIÓN / DESCRIPTION

PA-Y/2	Perfil aluminio forma Y / Aluminum profile shape Y
DF-O/2Y	Difusor opal perfil PA-Y / Opal diffuser profiles PA-Y
TFS-Y/2	Tapón final para perfil Y / End cap for profile Y
GR-Y	Grapa sujeción para perfil Y / Clip for profile Y

PERFIL DE ALUMINIO PARA ZÓCALOS SOCLE ALUMINUM PROFILE

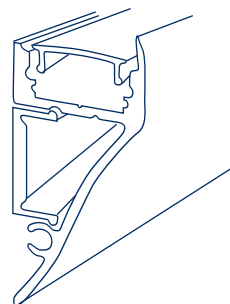
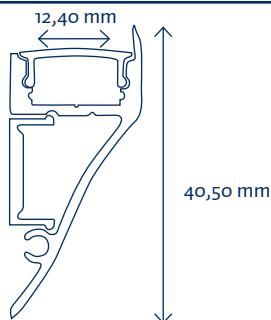

Perfil de aluminio anodizado para zócalos, ideal para tiras LED rígidas o flexibles. Tanto los perfiles como los difusores se entregan en tramos de 2m.

Anodized aluminum for socle ideal for flexible or rigid strip. Diffusers and profiles are supplied 2 mts/pcs.

DESCRIPCIÓN / DESCRIPTION

PA-ZR/2	Perfil aluminio para zócalos / Aluminum profile for skirting boards
DF-O/2	Difusor opal perfil PA-SM, SE, EM, EE, ET, AD18/2 y ZR / Opal diffuser profiles PA-SM, SE, EM, EE, ET, AD18/2 and ZR
TFS-ZR/2	Tapón final para perfil ZR / End cap for profile ZR
GR-ZR/2	Grapa sujeción para perfil ZR / Clip for profile ZR
GR-P/2CC	Grapa para perfil PA-CC, PA-ZR y GR-Y
GR-Y	=GR-P/2CC Grapa para perfil PA-CC, PA-ZR y GR-Y

NOVEDAD

PERFILES Y ACCESORIOS

PERFIL ALUMINIO EMPOTRAR ASIMETRICO INDIRECTO BLANCO

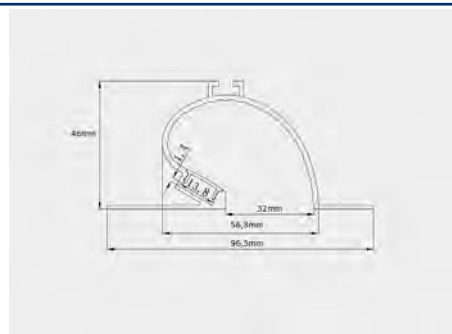
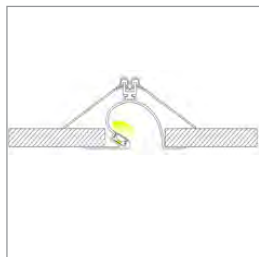
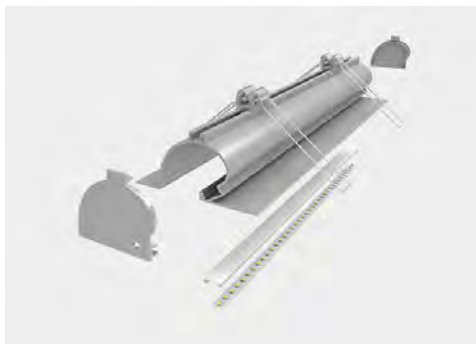

Perfil de aluminio anodizado para empotrar ideal para tiras LED rígidas o flexibles. Tanto los perfiles como los difusores se entregan en tramos de 2 mts.

The Anodized aluminum recessed profile is ideal for rigid or flexible LED strip. Diffusers and profiles are supplied 2 mts/pcs.

DESCRIPCIÓN / DESCRIPTION

PA-ERA/2B	Perfil aluminio de empotrar asimétrico indirecto blanco
TFC-ERA/2B	Tapa final para perfil aluminio de empotrar asimétrico indirecto blanco
GR-P/MERA	Grapa para perfil aluminio de empotrar asimétrico indirecto blanco
DF-O/2	Difusor opal perfil PA-SM, SE, EM, EE y ET / Opal diffuser for profile PA-SM, SE, EM, EE y ET
DF-T/2	Difusor transparente perfil PA-SM, SE, EM, EE y ET / Transparent diffuser profile PA-SM, SE, EM, EE y ET
DF-ST/2	Difusor semi-transparente perfil PA-SM, SE, EM, EE Y ET / Semi-transparent diffuser profile PA-SM, SE, EM, EE and ET
DFO6o-T/2	Difusor con óptica perfil PA-SM, SE, EM, EE Y ET / Optical diffuser profile PA-SM, SE, EM, EE and ET

PERFIL ALUMINIO PLANO TROQUELADO

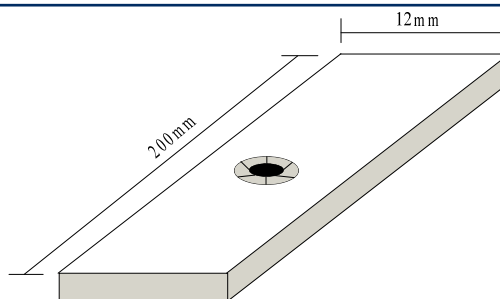
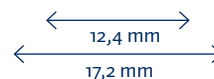

Perfil de aluminio anodizado plano ideal para tiras LED rígidas o flexibles. Los perfiles se entregan en tramos de 2 mts.

Corner round the Anodized aluminum recessed profile is ideal for rigid or flexible LED strip. Profiles are supplied 2 mts/pcs.

DESCRIPCIÓN / DESCRIPTION

PA-S/2	Perfil aluminio simple troquelada de 12mm
--------	---

NOVEDAD

PERFILES Y ACCESORIOS

PERFIL ALUM. EMPOTRAR ESTÁNDAR BLANCO

STANDARD RECESSED ALUM. PROFILE WHITE

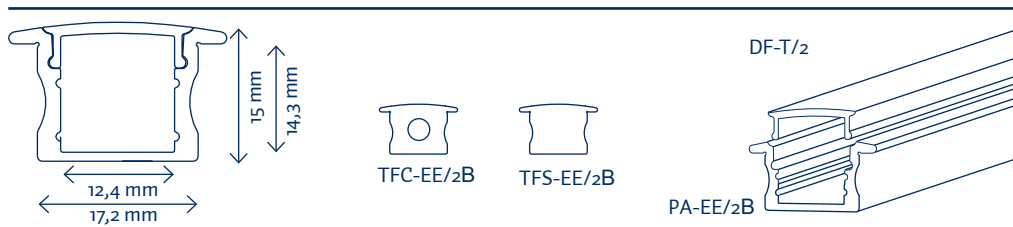

Perfil de aluminio anodizado para empotrar ideal para tiras led rígidas o flexibles. Tanto los perfiles como los difusores se entregan en tramos de 2 mts.

Anodized aluminum recessed profile, ideal for flexible or rigid strips. Diffusers and profiles are supplied 2 mts/pcs. pieces.

DESCRIPCIÓN / DESCRIPTION

PA-EE/2B	Perfil aluminio empotrar estándar blanco / Aluminum standard recessed profile
TFS-EE/2B	Tapón final para perfil empotrar estándar blanco/ End cap for standard recessed profile
TFC-EE/2B	Tapón final para perfil empotrar estándar c/agujero blanco / End cap with hole for standard recessed profile
DF-T/2	Difusor transparente perfil PA-SM, SE, EM, EE y ET / Transparent diffuser for profile PA-SM, SE, EM, EE and ET
DF-ST/2	Difusor semi-transparente perfil PA-SM, SE, EM, EE Y ET / Semi-transparent diffuser profile PA-SM, SE, EM, EE and ET
DF-O/2	Difusor opal perfil PA-SM, SE, EM, EE y ET / Opal diffusotr for profiles PA-SM, SE, EM, EE y ET
DFO6o-T/2	Difusor con óptica perfil PA-SM, SE, EM, EE Y ET / Optical diffuser profile PA-SM, SE, EM, EE and ET

PERFIL ALUMINIO SUPERFÍCIE ESTÁNDAR BLANCO

STANDARD ALUMINUM PROFILE WHITE

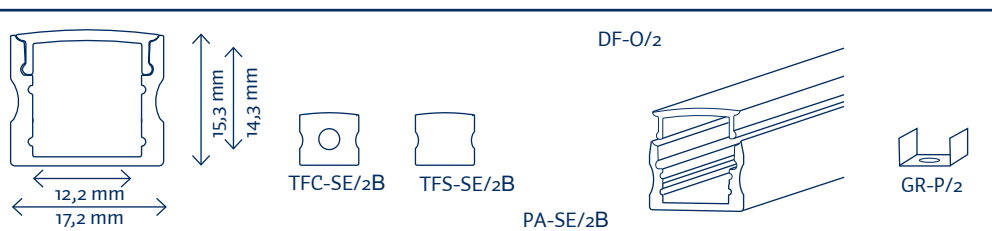
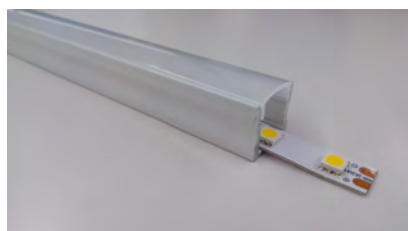

Perfil de aluminio anodizado de superficie ideal para tiras led rígidas o flexibles. Tanto los perfiles como los difusores se entregan en tramos de 2 mts.

Anodized aluminum surface profile, ideal for flexible or rigid strips. Diffusers and profiles are supplied 2 mts/pcs.

DESCRIPCIÓN / DESCRIPTION

PA-SE/2B	Perfil aluminio superficie estándar blanco/ Aluminum standard surface profile
TFS-SE/2B	Tapón final para perfil estándar blanco/ End cap for standard profile
TFC-SE/2B	Tapón final para perfil estándar c/agujero blanco / End cap with hole for standard profile
DF-T/2	Difusor transparente perfil PA-SM, SE, EM, EE y ET / Transparent diffuser for profile PA-SM, SE, EM, EE and ET
DF-ST/2	Difusor semi-transparente perfil PA-SM, SE, EM, EE Y ET / Semi-transparent diffuser profile PA-SM, SE, EM, EE and ET
DF-O/2	Difusor opal perfil PA-SM, SE, EM, EE y ET / Opal diffusotr for profiles PA-SM, SE, EM, EE y ET
DFO6o-T/2	Difusor con óptica perfil PA-SM, SE, EM, EE Y ET / Optical diffuser profile PA-SM, SE, EM, EE and ET
GR-P/2	Grapa sujeción perfil para PA-SE/2 / Clip for PA-SE/2 profile

NOVEDAD

PERFILES Y ACCESORIOS

PERFIL ALUM. EMPOTRAR ESTÁNDAR NEGRO

STANDARD RECESSED ALUM. PROFILE BLACK

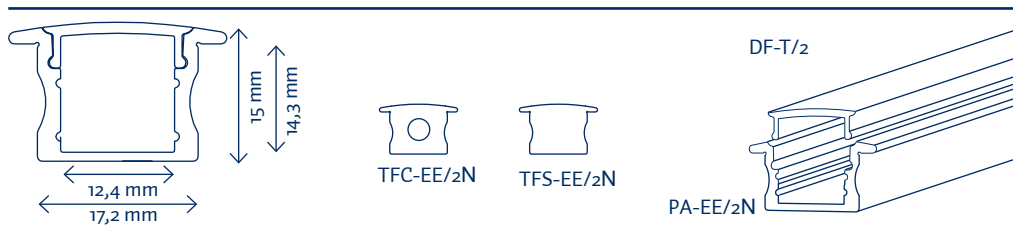

Perfil de aluminio anodizado para empotrar ideal para tiras led rígidas o flexibles. Tanto los perfiles como los difusores se entregan en tramos de 2 mts.

Anodized aluminum recessed profile, ideal for flexible or rigid strips. Diffusers and profiles are supplied 2 mts/pcs. pieces.

DESCRIPCIÓN / DESCRIPTION

PA-EE/2N	Perfil aluminio empotrar estándar negro / Aluminum standard recessed profile
TFS-EE/2N	Tapón final para perfil empotrar estándar negro/ End cap for standard recessed profile
TFC-EE/2N	Tapón final para perfil empotrar estándar c/agujero negro / End cap with hole for standard recessed profile
DF-T/2	Difusor transparente perfil PA-SM, SE, EM, EE y ET / Transparent diffuser for profile PA-SM, SE, EM, EE and ET
DF-ST/2	Difusor semi-transparente perfil PA-SM, SE, EM, EE Y ET / Semi-transparent diffuser profile PA-SM, SE, EM, EE and ET
DF-O/2	Difusor opal perfil PA-SM, SE, EM, EE y ET / Opal diffusotr for profiles PA-SM, SE, EM, EE y ET
DFO60-T/2	Difusor con óptica perfil PA-SM, SE, EM, EE Y ET / Optical diffuser profile PA-SM, SE, EM, EE and ET

PERFIL ALUMINIO SUPERFÍCIE ESTÁNDAR NEGRO

STANDARD ALUMINUM PROFILE BLACK

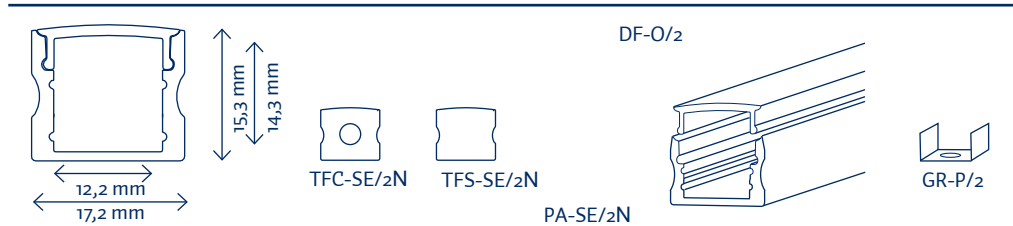
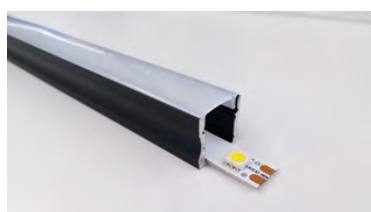

Perfil de aluminio anodizado de superficie ideal para tiras led rígidas o flexibles. Tanto los perfiles como los difusores se entregan en tramos de 2 mts.

Anodized aluminum surface profile, ideal for flexible or rigid strips. Diffusers and profiles are supplied 2 mts/pcs.

DESCRIPCIÓN / DESCRIPTION

PA-SE/2N	Perfil aluminio superficie estándar negro/ Aluminum standard surface profile
TFS-SE/2N	Tapón final para perfil estándar negro/ End cap for standard profile
TFC-SE/2N	Tapón final para perfil estándar c/agujero negro / End cap with hole for standard profile
DF-T/2	Difusor transparente perfil PA-SM, SE, EM, EE y ET / Transparent diffuser for profile PA-SM, SE, EM, EE and ET
DF-ST/2	Difusor semi-transparente perfil PA-SM, SE, EM, EE Y ET / Semi-transparent diffuser profile PA-SM, SE, EM, EE and ET
DF-O/2	Difusor opal perfil PA-SM, SE, EM, EE y ET / Opal diffusotr for profiles PA-SM, SE, EM, EE y ET
DFO60-T/2	Difusor con óptica perfil PA-SM, SE, EM, EE Y ET / Optical diffuser profile PA-SM, SE, EM, EE and ET
GR-P/2	Grapa sujeción perfil para PA-SE/2 / Clip for PA-SE/2 profile

PERFIL ALUMINIO EMPOTRAR MINI BLANCO

MINI RECESSED ALUMINUM PROFILE WHITE

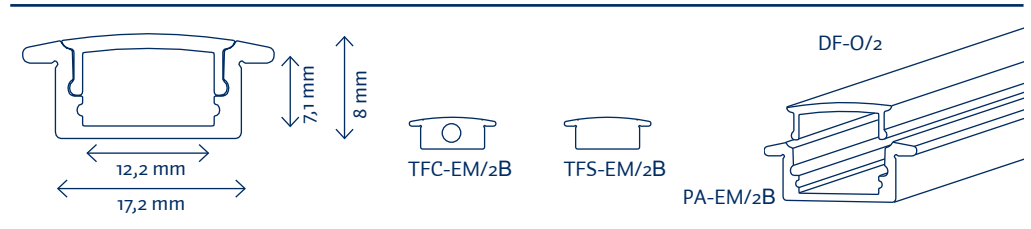

Perfil de aluminio anodizado para empotrar mini ideal para tiras LED rígidas o flexibles. Tanto los perfiles como los difusores se entregan en tramos de 2 mts.

The mini Anodized aluminum recessed profile is ideal for rigid or flexible LED strip. Diffusers and profiles are supplied 2 mts/pcs.

DESCRIPCIÓN / DESCRIPTION

PA-EM/2B	Perfil aluminio empotrar mini blanco/ Mini aluminum recessed profile white
TFS-EM/2B	Tapón final para perfil empotrar mini blanco / End cap for mini recessed profile white
TFC-EM/2B	Tapón final para perfil empotrar mini con agujero blanco / End cap for mini recessed profile with hole
DF-T/2	Difusor transparente perfil PA-SM, SE, EM, EE y ET / Transparent diffuser profile PA-SM, SE, EM, EE y ET
DF-ST/2	Difusor semi-transparente perfil PA-SM, SE, EM, EE Y ET / Semi-transparent diffuser profile PA-SM, SE, EM, EE and ET
DF-O/2	Difusor opal perfil PA-SM, SE, EM, EE y ET / Opal diffuser for profile PA-SM, SE, EM, EE y ET
DFO6o-T/2	Difusor con óptica perfil PA-SM, SE, EM, EE Y ET / Optical diffuser profile PA-SM, SE, EM, EE and ET

PERFIL ALUMINIO SUPERFICIE MINI BLANCO

MINI SURFACE ALUMINUM PROFILE WHITE

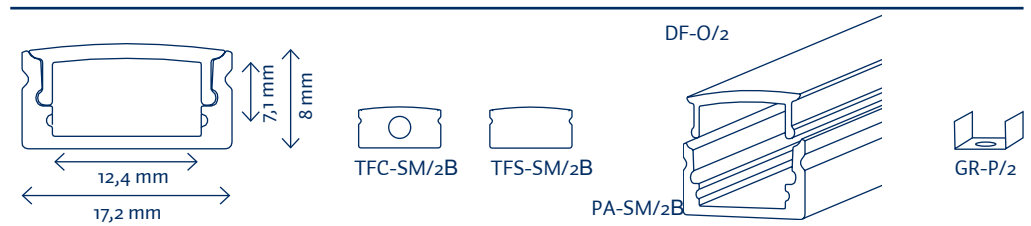
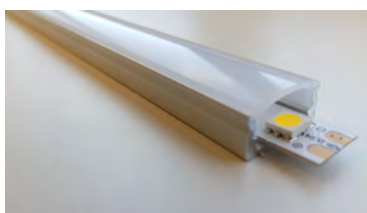

Perfil de aluminio anodizado mini ideal para tiras LED rígidas o flexibles. Tanto los perfiles como los difusores se entregan en tramos de 2 mts.

Corner round the mini Anodized aluminum recessed profile is ideal for rigid or flexible LED strip. Diffusers and profiles are supplied 2 mts/pcs.

DESCRIPCIÓN / DESCRIPTION

PA-SM/2B	Perfil aluminio superficie mini blanco/ Mini aluminum surface profile
TFS-SM/2B	Tapón final para perfil superficie mini blanco / End cap for mini surface profile
TFC-SM/2B	Tapón final para perfil superficie mini c/agujero blanco/ End cap for minisurface profile with hole
DF-T/2	Difusor transparente perfil PA-SM, SE, EM, EE y ET / Transparent diffuser profile PA-SM, SE, EM, EE y ET
DF-ST/2	Difusor semi-transparente perfil PA-SM, SE, EM, EE Y ET / Semi-transparent diffuser profile PA-SM, SE, EM, EE and ET
DF-O/2	Difusor opal perfil PA-SM, SE, EM, EE y ET / Opal diffuser profile PA-SM, SE, EM, EE y ET
DFO6o-T/2	Difusor con óptica perfil PA-SM, SE, EM, EE Y ET / Optical diffuser profile PA-SM, SE, EM, EE and ET
GR-P-2	Grapa sujeción perfil para PA-SM/2 / Clip profile PA-SM/2

NOVEDAD

PERFILES Y ACCESORIOS

PERFIL ALUMINIO EMPOTRAR MINI NEGRO

MINI RECESSED ALUMINUM PROFILE BLACK

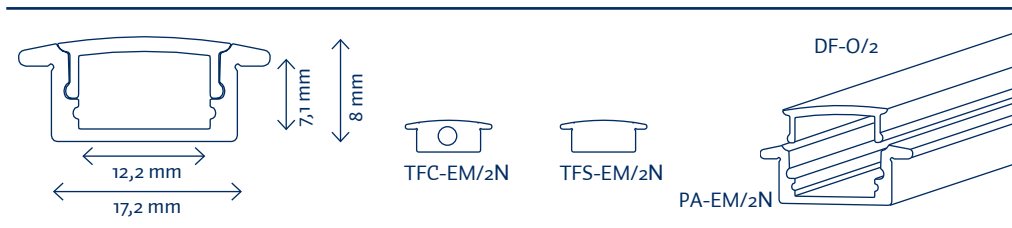

Perfil de aluminio anodizado para empotrar mini ideal para tiras LED rígidas o flexibles. Tanto los perfiles como los difusores se entregan en tramos de 2 mts.

The mini Anodized aluminum recessed profile is ideal for rigid or flexible LED strip. Diffusers and profiles are supplied 2 mts/pcs.

DESCRIPCIÓN / DESCRIPTION

PA-EM/2N	Perfil aluminio empotrar mini negro/ Mini aluminum recessed profile
TFS-EM/2N	Tapón final para perfil empotrar mini negro / End cap for mini recessed profile
TFC-EM/2N	Tapón final para perfil empotrar mini con agujero negro / End cap for mini recessed profile hole
DF-T/2	Difusor transparente perfil PA-SM, SE, EM, EE y ET / Transparent diffuser profile PA-SM, SE, EM, EE y ET
DF-ST/2	Difusor semi-transparente perfil PA-SM, SE, EM, EE Y ET / Semi-transparent diffuser profile PA-SM, SE, EM, EE and ET
DF-O/2	Difusor opal perfil PA-SM, SE, EM, EE y ET / Opal diffuser for profile PA-SM, SE, EM, EE y ET
DFO60-T/2	Difusor con óptica perfil PA-SM, SE, EM, EE Y ET / Optical diffuser profile PA-SM, SE, EM, EE and ET

PERFILES Y ACCESORIOS / PROFILES AND ACCESSORIES

PERFIL ALUMINIO SUPERFICIE MINI NEGRO

MINI SURFACE ALUMINUM PROFILE BLACK

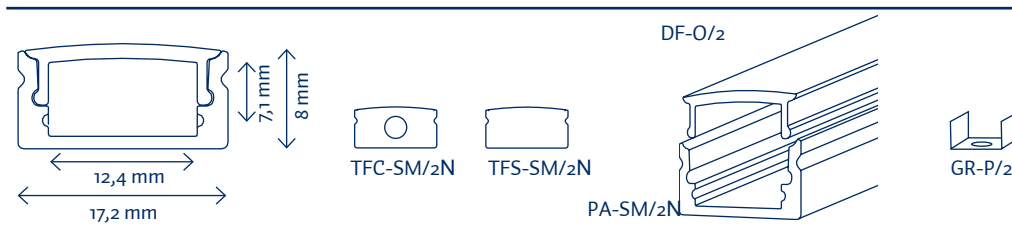

Perfil de aluminio anodizado mini ideal para tiras LED rígidas o flexibles. Tanto los perfiles como los difusores se entregan en tramos de 2 mts.

Corner round the mini Anodized aluminum recessed profile is ideal for rigid or flexible LED strip. Diffusers and profiles are supplied 2 mts/pcs.

DESCRIPCIÓN / DESCRIPTION

PA-SM/2N	Perfil aluminio superficie mini negro/ Mini aluminum surface profile
TFS-SM/2N	Tapón final para perfil superficie mini negro / End cap for mini surface profile
TFC-SM/2N	Tapón final para perfil superficie mini c/agujero negro/ End cap for minisurface profile with hole
DF-T/2	Difusor transparente perfil PA-SM, SE, EM, EE y ET / Transparent diffuser profile PA-SM, SE, EM, EE y ET
DF-ST/2	Difusor semi-transparente perfil PA-SM, SE, EM, EE Y ET / Semi-transparent diffuser profile PA-SM, SE, EM, EE and ET
DF-O/2	Difusor opal perfil PA-SM, SE, EM, EE y ET / Opal diffuser profile PA-SM, SE, EM, EE y ET
DFO60-T/2	Difusor con óptica perfil PA-SM, SE, EM, EE Y ET / Optical diffuser profile PA-SM, SE, EM, EE and ET
GR-P-2	Grapa sujeción perfil para PA-SM/2 / Clip profile PA-SM/2

SENSOR DE CONTACTO PARA PERFILES

CONTACT SENSOR FOR PROFILES

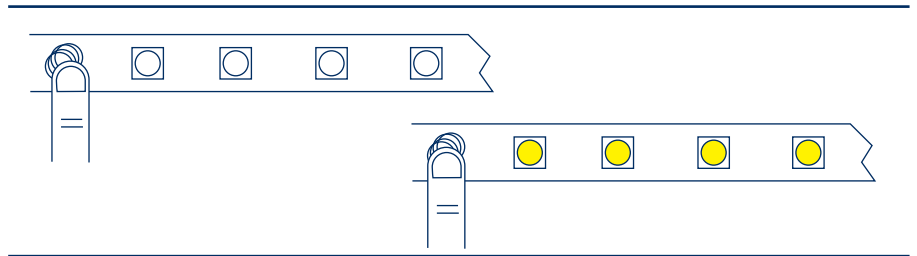

Sensor de aproximación para el control y regulación de tiras de leds para instalación interna en perfiles de aluminio. Encendido por aproximación del dedo, regulación mediante contacto continuado y apagado mediante contacto. Luz testigo en color azul.

Managing sensor for led strips installed in aluminum profile. Switching on by proximity, managing by contact and switching off by contact. It has a blue light to indicate if the item is on.

	ALIMENTACIÓN POWER SUPPLY	SENSOR SENSOR	CARGA MÀX. MAX. CHARGE	MEDIDAS DIMENSIONS	COMENTARIO REMARKS
BS-3R	12-24VDC	Aproximación / Approach	60W (12V) – 120W (24V)	50x8mm	Regulador para instalar en perfiles PA/ Sensor to install in PA profiles

SENSOR DE PROXIMIDAD PARA PERFILES

PROXIMITY SENSORS FOR PROFILES

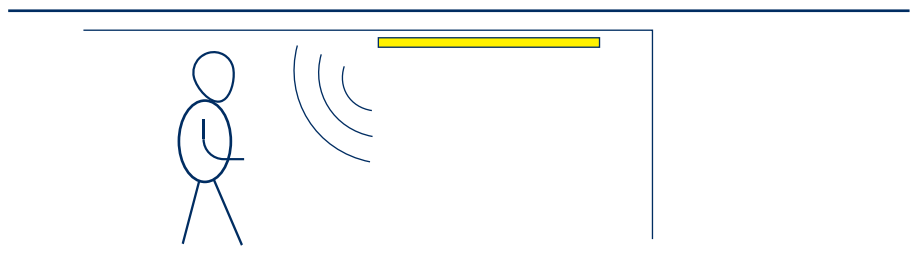

Sensor PIR de movimiento para el control y regulación de tiras de leds para instalación interna en perfiles de aluminio. Se enciende al detectar movimiento a 2 metros de distancia y se apaga automáticamente. El dispositivo de iluminación equipado con este Sensor PIR permanecerá encendido si la detección se mantiene. Se apagará en 40 segundos después de dejar de detectar.

PIR Sensor turns on when a movement is detected within 2 meters away and will off automatically after leaving to detect.it during 40 seconds.

	ALIMENTACIÓN POWER SUPPLY	SENSOR SENSOR	CARGA MÀX. MAX. CHARGE	MEDIDAS DIMENSIONS	COMENTARIO REMARKS
BS-PIR	12-24VDC	PIR	60W (12V) – 120W (24V)	40x10mm	Regulador para instalar en perfiles PA/ Sensor to install in PA profiles

KIT DE SUSPENSIÓN DE PERFILES

SUSPENSION KIT TO PROFILE



60
/
61

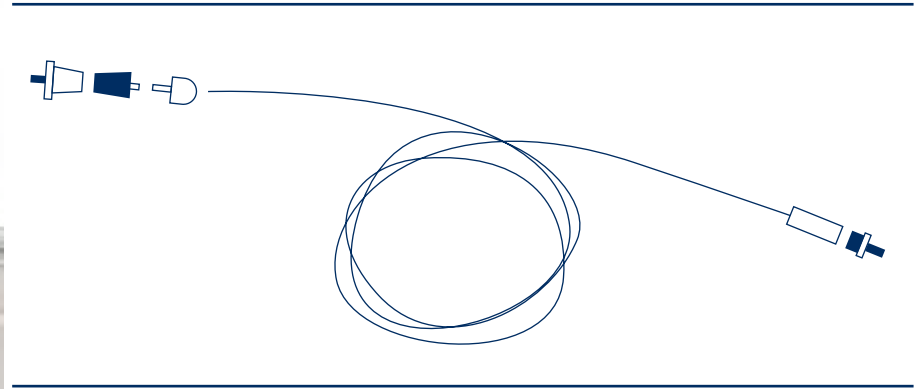

Kit compuesto de cable de acero de 3m, fijación a techo y soporte para perfil de aluminio. Apto para cualquier perfil serie PA.

Kit provided with 3m steel cable, ceiling mounting and support for aluminum profile. Suitable for any PA profile series.

DESCRIPCIÓN / DESCRIPTION

KIT-CA

Kit completo para suspensión de perfiles de aluminio / Full kit to suspension aluminum profile

GRAPA FIJACIÓN 180°

ROTARY CLIP 180°

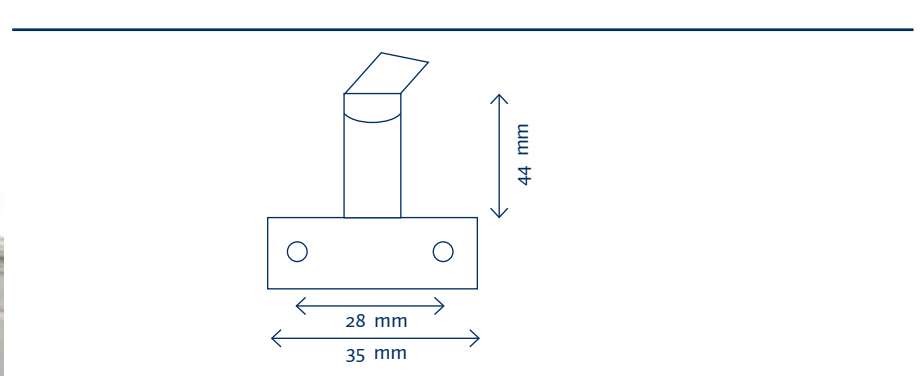

Grapa de fijación a pared-techo con sistema giratorio que permite orientar la luminaria hacia cualquier posición. No incluye la grapa adaptable a cada perfil.

Wall mounting clip with rotary system to guide the light to any position. It does not include adaptable clip to each profile.

DESCRIPCIÓN / DESCRIPTION

GR-P180

Grapa orientable 180° / Rotary clip 180°

“Desde 1984 junto a ti
iluminando tu camino”

“Lighting your way
with you since 1984”



FUENTES Y CONTROLADORES

03

DRIVERS AND
CONTROLLERS

64
/
65



FUENTES DE CORRIENTE CONSTANTE CONSTANT CURRENT DRIVERS



Fuentes de corriente constante para alimentar a equipos led de potencia con una señal precisa desde 1W a 40W. Corriente estándar 350mA y 700mA. También disponible en corrientes de 500mA o 1050mA. Los equipos LCM son totalmente regulables y configurables.

Constant current drivers to supply from 1W to 40W. Standard current 350mA and 700mA. They are also available in 500mA or 1050mA. The LCM equipment are fully adjustable and configurable.

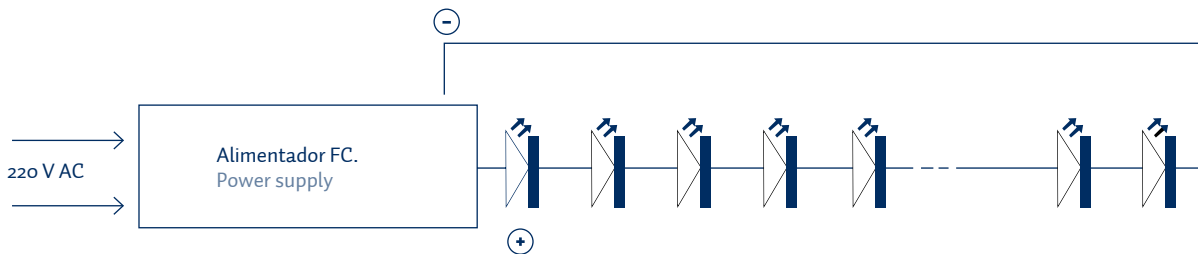

	ALIMENTACIÓN POWER SUPPLY	SALIDA OUTPUT	MEDIDA SIZE	APROPIADO PROPERTY	RANGO DE TENSIÓN VOLTAGE RANGE
FC3501X1	170-230VAC	350mA	43x24,5x19mm	1 led 1W	2-12VDC
FC3503X1	170-230VAC	350mA	43x24,5x19mm	2-3 leds 1W	8-18VDC
APC08-350	90-264VAC	350mA	60x30x22mm	4-7 leds 1W	11-23VDC
APC08-700	90-264VAC	700mA	60x30x22mm	2 leds 3W	5-11VDC
APC12-350	90-264VAC	350mA	118x38x22mm	3-12 leds 1W	9-36VDC
APC12-700	90-264VAC	700mA	43x24,5x19mm	2-4 leds 3W	9-18VDC
APC16-350	90-264VAC	350mA	77x40x29mm	4-16 leds 1W	12-48VDC
APC16-700	90-264VAC	700mA	77x40x29mm	2-5 leds 3W	9-24VDC
APC25-350	90-264VAC	350mA	84x57x29,5mm	8-23 leds 1W	25-70VDC
APC25-700	90-264VAC	700mA	84x57x29,5mm	2-8 leds 3W	11-36VDC
APC35-350	90-264VAC	350mA	84x57x29,5mm	10-33 leds 1W	28-100VDC
APC35-700	90-264VAC	700mA	84x57x29,5mm	3-11 leds 3W	15-50VDC
LCM-25	180-277VAC	350 a 1050mA / 350 to 1050mA	105x68x23mm	Variable	6-(24/54V)DC
LCM-40	180-295VAC	350 a 1050mA / 350 to 1050mA	123 x81x29,5mm	Variable	2-(40/100V)DC



FUENTES DE TENSIÓN CONSTANTE PARA INTERIOR

INDOOR CONSTANT TENSION DRIVERS



Fuentes conmutadas de tensión constante 12V DC o 24V DC para una señal precisa en la alimentación de equipos LED.

Constant tension drivers 12V DC or 24V DC supply LED device with a precise signal.

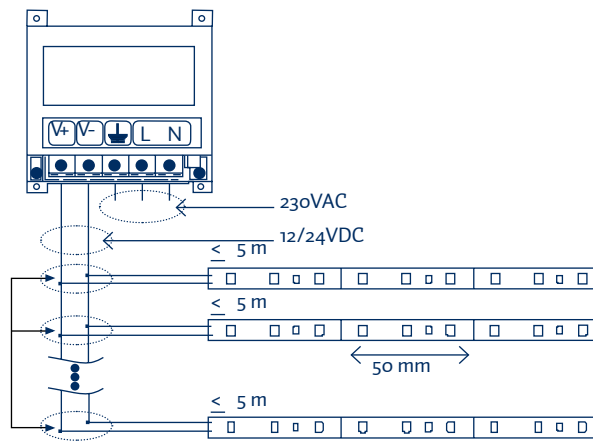

	ENTRADA INPUT	TENSIÓN TENSION	POTENCIA POWER	MEDIDA MESURE
FT120,25	170-230V AC	12V DC	3W	45x38x19mm
FT120,75	170-230V AC	12V DC	9W	118x38x22mm
FT121,25	170-230V AC	12V DC	15W	118x38x22mm
RS2512	170-230V AC	12V DC	25W	79x51x28mm
LRS3512	170-230V AC	12V DC	35W	99x82x30mm
LRS5012	170-230V AC	12V DC	50W	99x82x30mm
LRS7512	170-230V AC	12V DC	75W	99x97x30mm
LRS10012	170-230V AC	12V DC	100W	129x97x30mm
LRS15012	170-230V AC	12V DC	150W	159x97x30mm
RSP20012	170-230V AC	12V DC	200W	215x115x30mm
SP24012	170-230V AC	12V DC	240W	190x93x50mm
RSP32012	170-230V AC	12V DC	320W	215x115x30mm

	ENTRADA INPUT	TENSIÓN TENSION	POTENCIA POWER	MEDIDA MESURE
RS2524	170-230V AC	24V DC	25W	79x51x28mm
LRS3524	170-230V AC	24V DC	35W	99x82x30mm
LRS5024	170-230V AC	24V DC	50W	99x82x30mm
LRS7524	170-230V AC	24V DC	75W	99x97x30mm
LRS10024	170-230V AC	24V DC	100W	129x97x30mm
LRS15024	170-230V AC	24V DC	150W	159x97x30mm
RSP20024	170-230V AC	24V DC	200W	215x115x30mm
SP24024	170-230V AC	24V DC	240W	190x93x50mm
RSP32024	170-230V AC	24V DC	320W	215x115x30mm



FUENTES DE TENSIÓN CONSTANTE PARA EXTERIOR

OUTDOOR CONSTANT TENSION DRIVERS



Fuentes conmutadas de tensión constante 12V DC o 24V DC de uso exterior con protección IP67 para una señal precisa en la alimentación de equipos LED.

Constant tension drivers 12V DC or 24V DC with IP67 protection for outdoor use. Supply LED device with a precise signal.

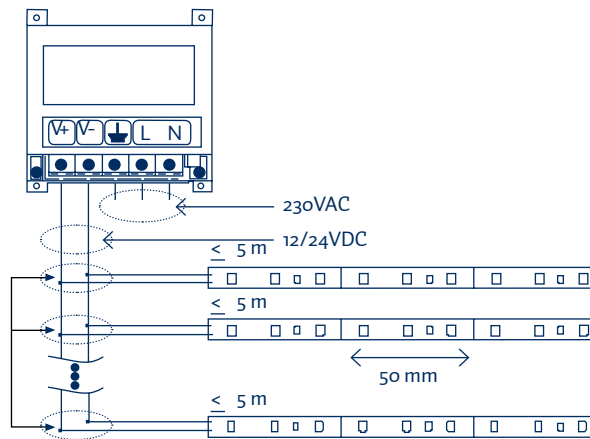

	ENTRADA INPUT	TENSIÓN TENSION	POTENCIA POWER	MEDIDA MESURE		ENTRADA INPUT	TENSIÓN TENSION	POTENCIA POWER	MEDIDA MESURE
LPV2012	170-250V AC	12V DC	20W	148x40x30mm	LPV2024	170-250V AC	24V DC	20W	148x40x30mm
LPV3512	170-250V AC	12V DC	35W	148x40x30mm	LPV3524	170-250V AC	24V DC	35W	148x40x30mm
LPV6012	170-250V AC	12V DC	60W	162,5x42,5x32mm	LPV6024	170-250V AC	24V DC	60W	162,5x42,5x32mm
LPV10012	170-250V AC	12V DC	100W	190x52x37mm	LPV10024	170-250V AC	24V DC	100W	190x52x37mm
LPV15012	170-250V AC	12V DC	150W	191x63x37,5mm	LPV15024	170-250V AC	24V DC	150W	191x63x37,5mm
HLG18512	170-250V AC	12V DC	185W	222,2x68x38,8mm	HLG18524	170-250V AC	24V DC	185W	222,2x68x38,8mm
HLG24012	170-250V AC	12V DC	240W	244,2x68x38,8mm	HLG24024	170-250V AC	24V DC	240W	244,2x68x38,8mm
HLG32012	170-250V AC	12V DC	320W	252x90x43,8mm	HLG32024	170-250V AC	24V DC	320W	252x90x43,8mm

FUENTES Y CONTROLADORES

RRGB



CVRRGB-L



CVRRGB-T



CVRRGB-E

CONTROLADORES RGB RGB CONTROLLERS



Controladores RGB manual o vía radio con múltiples funciones de selección de programa, velocidad y luminosidad. Salida PWM para control de dispositivos LED PWM de ánodo común.

Manual or via radio RGB controllers with multifunctions: programme, speed and brightness. PWM output for the control of common anode PWM LED devices.

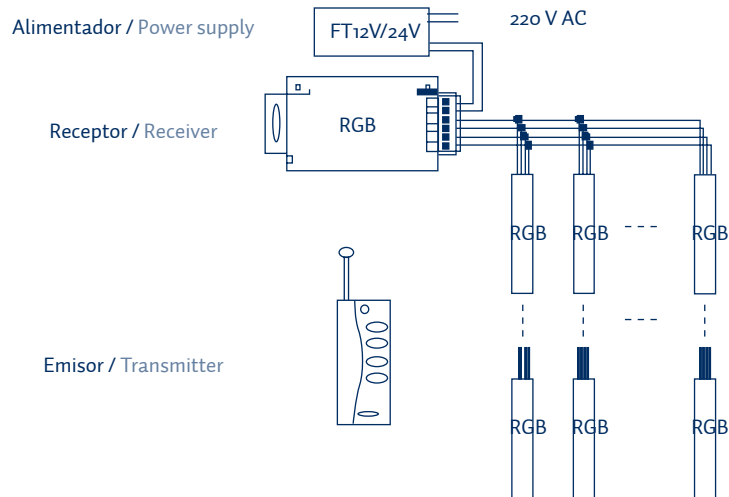

	ALIMENTACIÓN POWER SUPPLY	SALIDA OUTPUT	CARGA MÁX. MAX. CHARGE	MEDIDA MEASURE	CONEXIÓN CONNECTION
RRGB	12-24V DC	PWM 12-24V DC	3A canal/channel	130x40x51mm	Controlador manual / Manual controller
CVRRGB-L	12-24V DC	PWM 12-24V DC	3A canal/channel	130x40x51mm	Controlador con control en receptor / Controller with control as receiver
CVRRGB-E	12-24V DC	PWM 12-24V DC	4A canal/channel	104x65x24mm	Controlador con mando multi botón / Controller with multi-button remote control
CVRRGB-T	12-24V DC	PWM 12-24V DC	5A canal/channel	40x65x23mm	Controlador con mando touch / Controller with touch remote control



Diseño
Ultra-
plano

CONTROLADOR RGB SERIE M

RGB CONTROLLER SERIE M



Sistema de control RGB compuesto de emisor M3 y receptor. Emisión a 433MHz. Diseño de emisor ultrafino con paleta de color táctil. Pequeño receptor para ser instalado en pequeños espacios. Distancia de recepción hasta 50m.

RGB Control system is composed by a M3 transmitter and receiver. It emits 433MHz. Ultrathin design with color touching pad. Small receiver to be installed in small spaces. Reception distance until 50m.

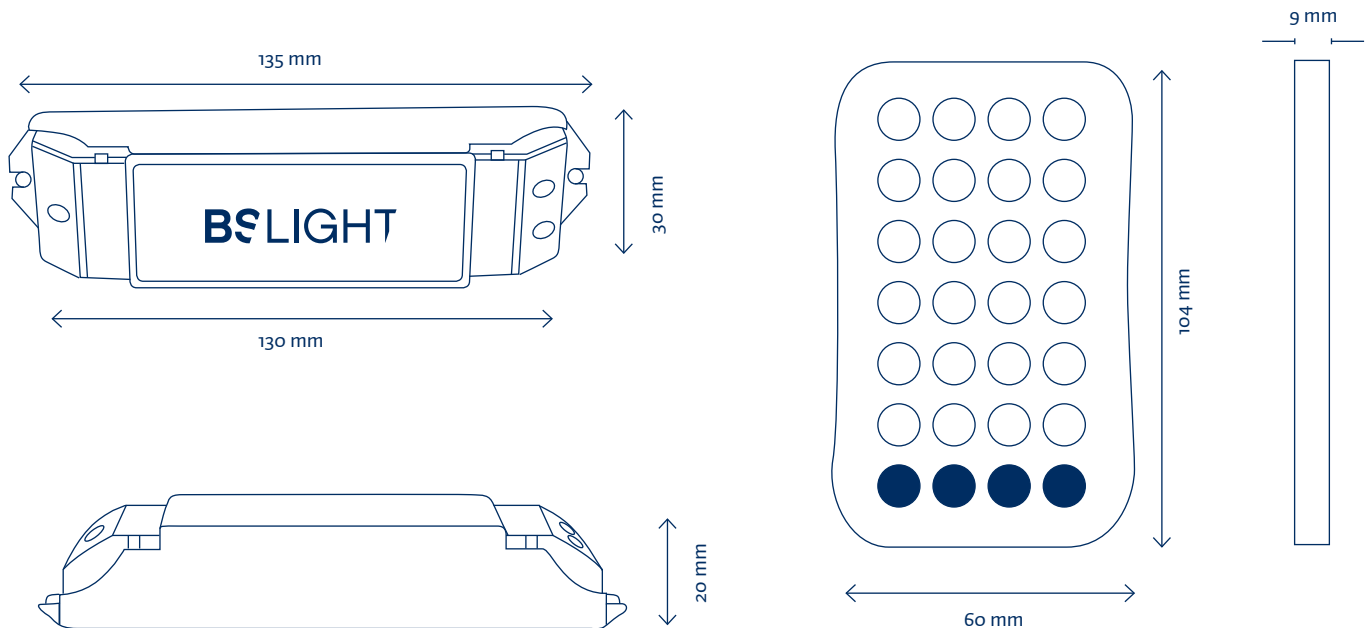

	ALIMENTACIÓN POWER SUPPLY	CARGA MÁX. MAX.CHARGE	MEDIDAS MEASURE	COMENTARIO REMARKS
CVRRGB-M	3VDC (CR2032) Emisor / Remote 12-24VDC Receptor / Receiver	5A x 3 canales / channel	135x30x20mm	Kit emisor + receptor / remote + receiver

2,4
GHz

RGB
+ W



CONTROLADOR RGBW SERIE V RGBW CONTROLLER SERIE V



Sistema de control RGBW compuesto de emisor V4 y receptores. Emisión a 2,4GHz para evitar interferencias. Receptores RF inalámbricos sin necesidad de cablear entre ellos.

RGBW Control system is composed by V4 transmitter with receiver. Issued to 2,4GHz to avoid interferences. Wireless receivers do not to wire up to each other. Can be possibility to control until 8 independent zones.

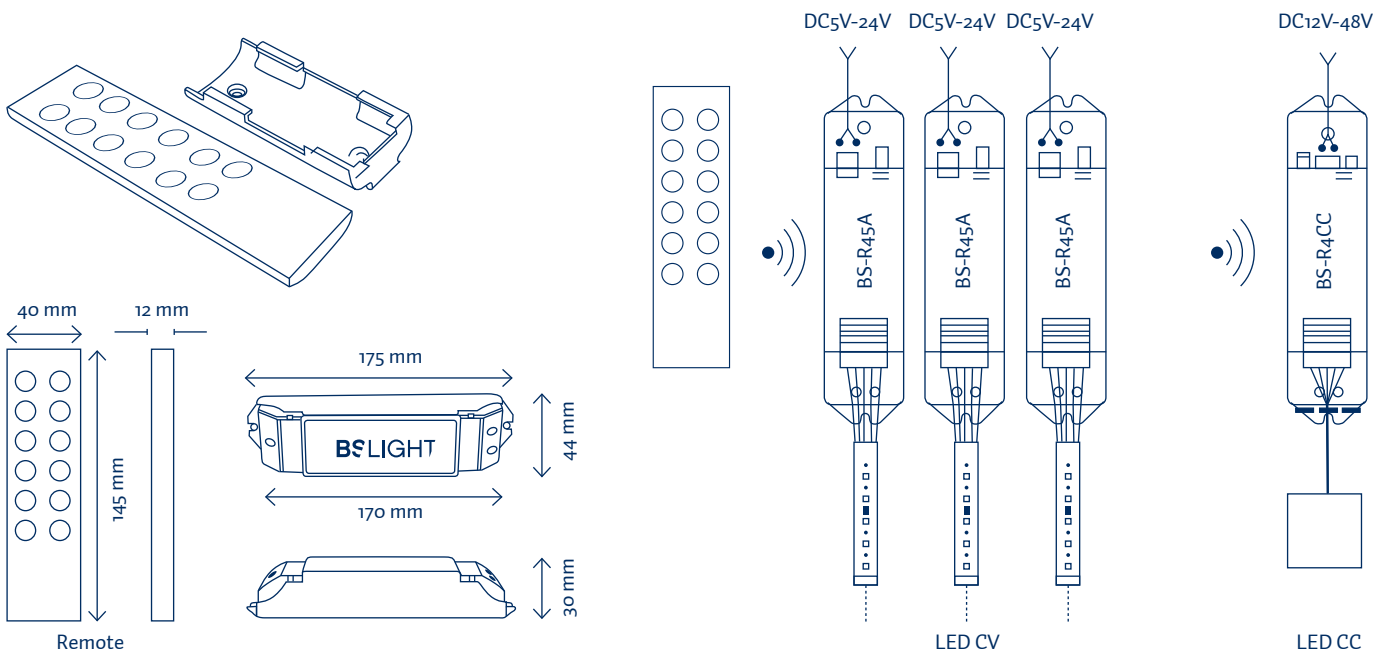

	ALIMENTACIÓN POWER SUPPLY	CARGA MÁX. MAX.CHARGE	MEDIDAS MEASURE	COMENTARIO REMARKS
BS-V4	3VDC (CR2032)	-	145x40x12	Emisor RF 2,4GHz / RF transmitter
BS-R45A	5-24VDC	5A x 4 canales / channels	175x44x30	Receptor RF tensión constante para BS-V4 / Constant voltage RF receiver to BS-V4
BS-R4CC	12-48VDC	350/700/1050mA x 4 canales / channels	175x44x30	Receptor RF corriente constante para BS-V4 / Constant current RF receiver to BS-V4

70
/
71



RGB
+ W

Multizona

CONTROL RGBW MULTIZONA TOUCH RGBW MULTIZONE



Sistema de control RGBW compuesto de mando emisor y receptores. Emisión de 2,4GHz para evitar interferencias. Receptores inalámbricos sin necesidad de cablear entre ellos. Posibilidad de controlar hasta 8 zonas independientemente.

RGBW control system is composed by a transmitter and receiver. It emits 2,4GHz to avoid interferences. Wireless receivers do not need to wire up to each other. Can be possible to control until 8 independent zones.

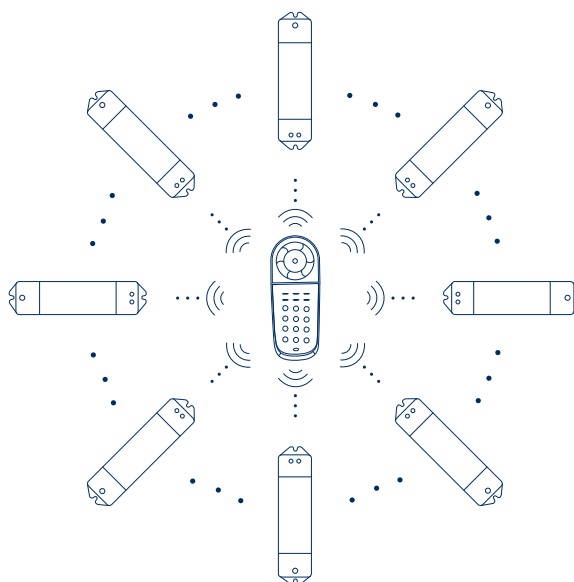
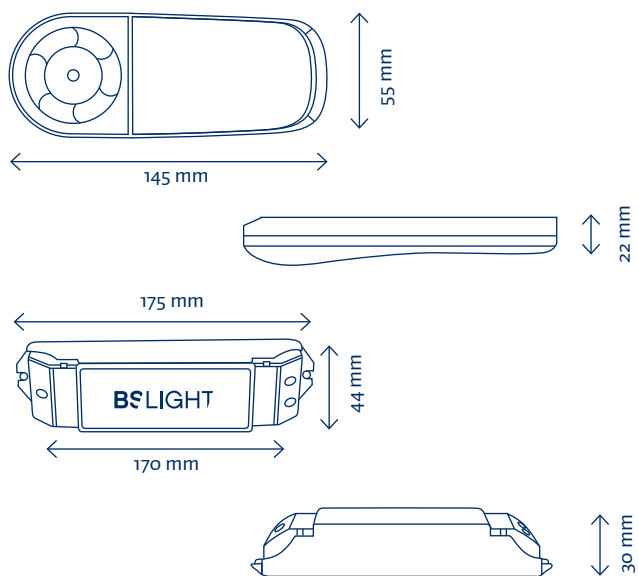

	ALIMENTACIÓN POWER SUPPLY	ZONAS ZONES	CARGA MÁX. MAX.CHARGE	MEDIDAS MEASURE	COMENTARIO REMARKS
BS-T4	batería 5V / Lithium battery	8	-	1145X55X22	Emisor RF para 8 zonas RGBW/RF transmitter to 8 RGBW zones
BS-T4CV	5-24VDC	-	5A x 4 canales / channels	175X44X30	Receptor tensión constante para BS-T4 / Constant voltage receiver to BS-T4
BS-T4CC	12-48VDC	-	350/700/1050mA x 3 canales / channels	175X44X30	Receptor corriente constante para BS-T4/ Constant current receiver to BS-T4

Multizona

RGB



BS-T3M



BS-T3CC

BS-T3CV

CONTROL RGB MULTIZONA TOUCH RGB MULTIZONE



Sistema de control RGB multizona compuesto de mando emisor y receptores. Emisión a 2,4GHz para evitar interferencias. Receptores inalámbricos sin necesidad de cablear entre ellos. Posibilidad de controlar hasta 10 zonas independientemente.

RGB control system is composed by a transmitter and receiver. It emits 2,4GHz to avoid interferences. Wireless receivers do not need to wire up to each other. Can be possibility to control until 10 independent zones.

FUENTES Y CONTROLADORES / DRIVERS AND CONTROLLERS

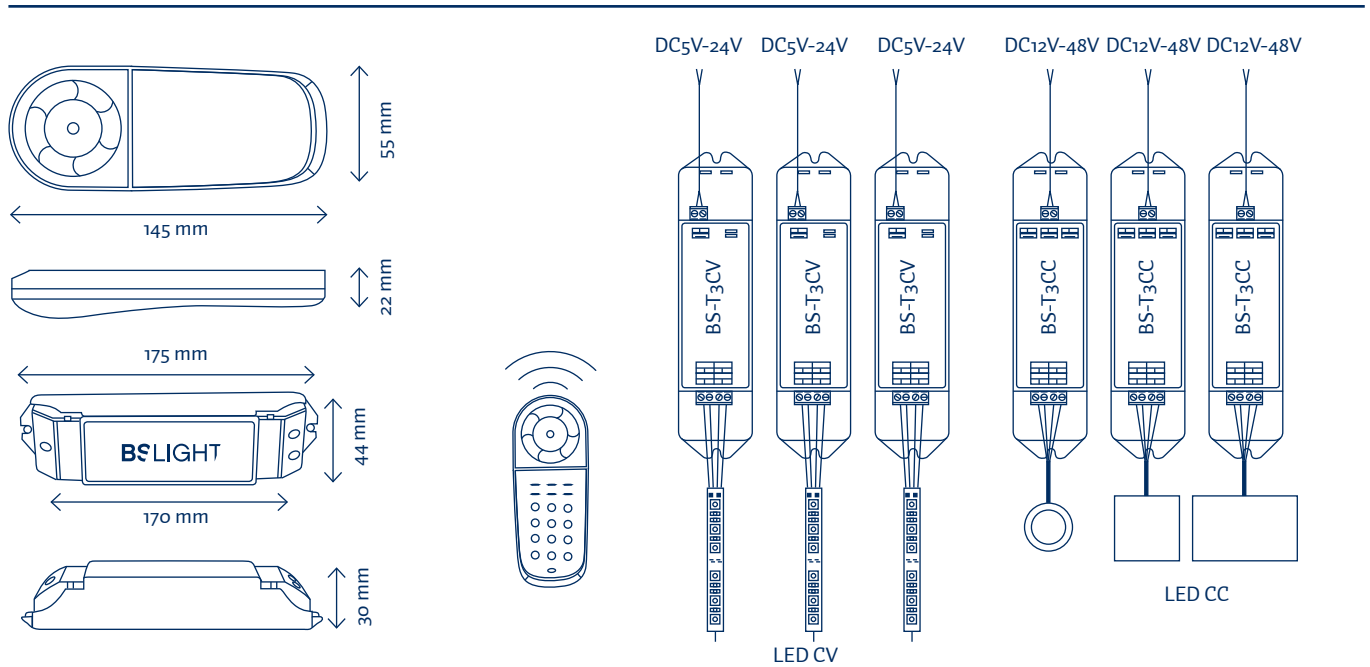

	ALIMENTACIÓN POWER SUPPLY	ZONAS ZONES	CARGA MÁX. MAX.CHARGE	MEDIDAS MEASURE	COMENTARIO REMARKS
BS-T3M	batería 5V / Lithium battery	10	-	145x55x22	Emisor RF para 10 zonas RGB/ RF transmitter to 10 RGB zones
BS-T3CV	5-24VDC	-	6A x 3 canales / channels	175x44x30	Receptor tensión constante para BS-T3M/ Constant voltage receiver to BS-T3M
BS-T3CC	12-48VDC	-	350/700/1050mA x 3 canales / channels	175x44x30	Receptor corriente constante para BS-T3M/ Constant current receiver to BS-T3M

72
/
73



PANEL TÁCTIL MURAL RGB TOUCH RGB PANEL MURAL



Paneles táctiles de instalación mural para el control de equipos RGB. Equipos preprogramados con diversos programas de color, luminosidad, temperatura de color... Diseñado para ser integrado e instalado en cajetín europeo empotrado standard en pared.

Touch panel mural installation for controlling single color, color temperature and RGB equipment. Teams preset programs with various color, brightness, color temperature ... Designed to be built and installed in standard recessed wall box.

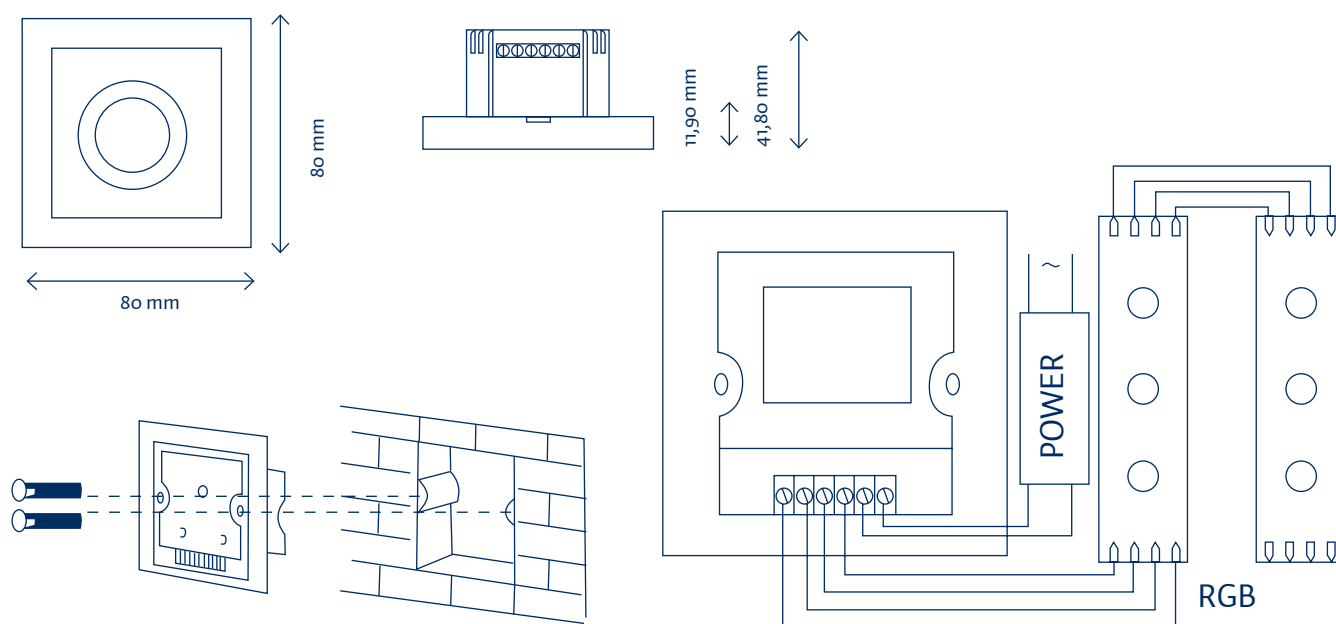

	ALIMENTACIÓN POWER SUPPLY	SALIDA OUTPUT	CARGA MÁX. MAX.CHARGE	MEDIDAS MEASURE	COMENTARIO REMARKS
TM08E	12-24VDC	3 canales PWM	5A x canal / channel	80x80x41mm	Controlador RGB / RGB controller

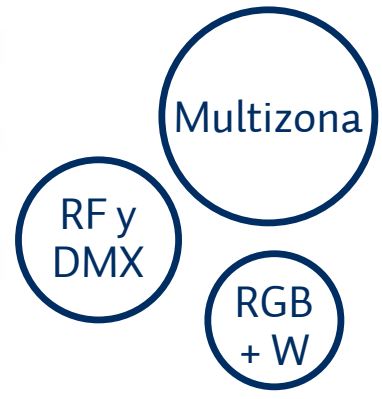

PANEL TÁCTIL MURAL RGBW RF + DMX

TOUCH PANEL MURAL RGBW RF + DMX



Sistema de control RGBW compuesto de panel táctil y receptores. Emisión a 2,4GHz para evitar interferencias. Receptores RF inalámbricos sin necesidad de cablear entre ellos. Posibilidad de controlar hasta 4 zonas independientemente. También se puede conectar mediante bus DMX con decodificadores estándares.

RGB control system is composed by a touch panel and receivers. Issued to 2,4GHz to avoid interferences. Wireless receivers RF do not need to wire up each other. They have the possibility to control 4 independent zones and also to connect through a standard bus DMX decoders.

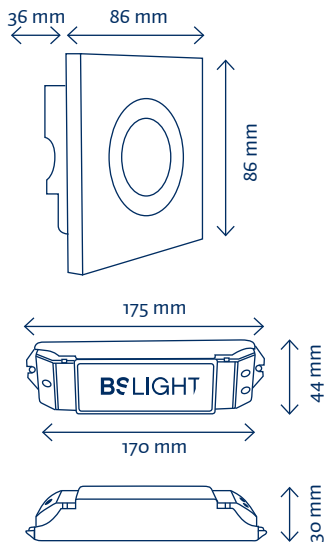

INSTALACIÓN BÁSICA / BASIC INSTALLATION

Sistema RF / RF system

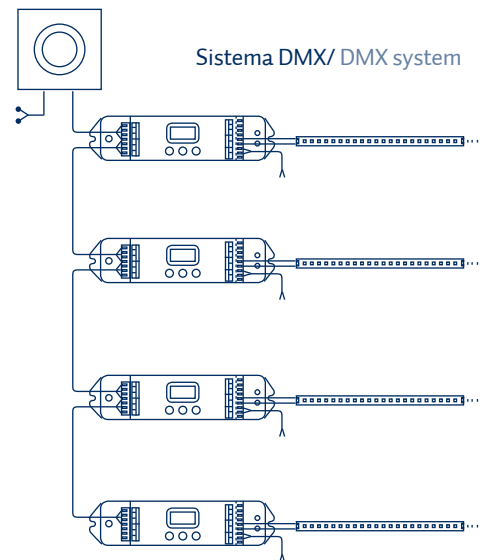
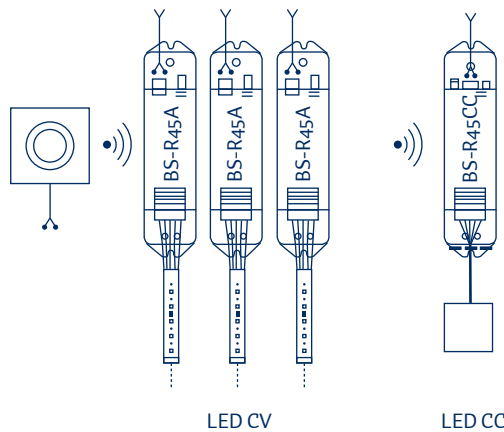

	ALIMENTACIÓN POWER SUPPLY	ZONAS ZONES	CARGA MÁX. MAX.CHARGE	MEDIDAS MEASURE	COMENTARIO REMARKS
BS-DX8	100-230VAC	4	-	145x55x22	Panel RF+DMX para 4 zonas RGBW / Panel RF+DMX to 4 zones RGBW
BS-R45A	5-24VDC	-	5A x 4 canales / channels	175x44x30	Receptor RF tensión constante para BS-DX8 / Constant voltage RF receiver to BS-DX8
BS-R4CC	12-48VDC	-	350/700/1050mA x 4 canales / channels	175x44x30	Receptor RF corriente constante para BS-DX8 / Constant current RF receiver to BS-DX8

Decodificadores DMX en página 86 / DMX decoders see page 86

74
/
75



WIFI

Multizona

CONTROLADOR WIFI CON APLICACIÓN IOS y ANDROID

WIFI CONTROLLER FOR IOS AND ANDROID



Sistema de control WIFI compuesto de emisor RF y receptor con sistema WIFI. Emisión a 2,4GHz para evitar interferencias. Receptor RF y WIFI para ser controlado por mando RF y por Smartphone o tablet. Posibilidad de controlar hasta 12 zonas independientemente. Estas zonas pueden ser monocolor, RGB, RGBW o sistemas de iluminación con cambio de temperatura de color.

WIFI system is composed by RF transmitter with WIFI system receiver. Issued to 2,4GHz to avoid interferences. RF receiver and WIFI to be controlled by RF control and Smartphone or tablet. They have the possibility to control 12 independent zones. They can be single-color, RGB, RGBW or lighting systems with color temperature change.

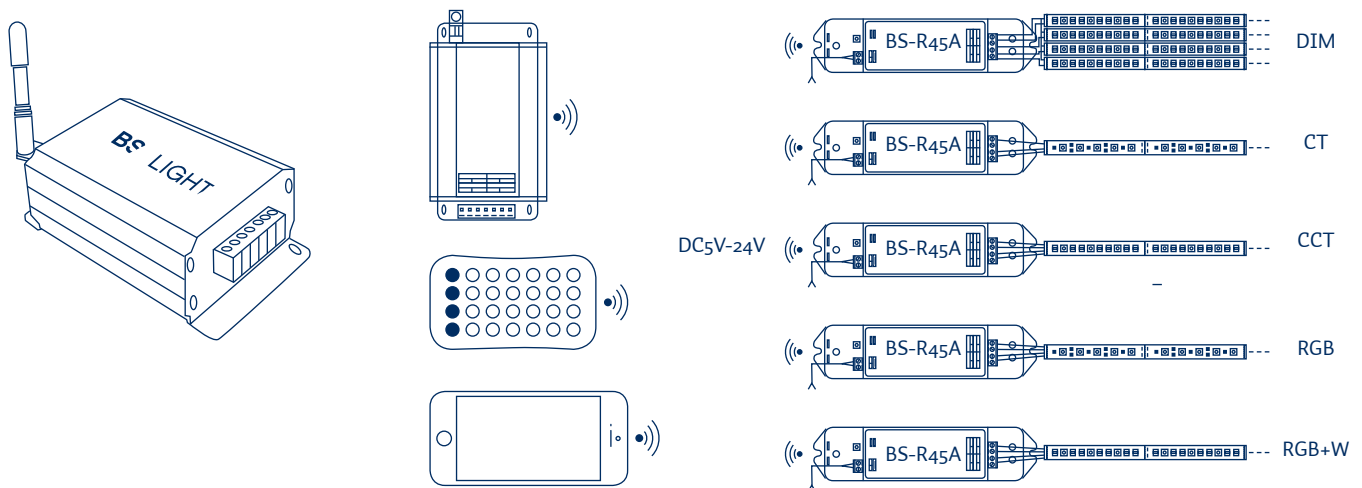

	ALIMENTACIÓN POWER SUPPLY	ZONAS ZONES	CARGA MÁX. MAX.CHARGE	MEDIDAS MEASURE	COMENTARIO REMARKS
BS-WIFI-104	12-24VDC	12	4A x 4 canales / channels	1145x55x22	Incluye mando emisor RF / RF control includes
BS-R45A	5-24VDC	-	5A x 4 canales / channels	175x44x30	Receptor RF tensión constante para BS-WIFI / Constant voltage RF receiver to BS-WIFI
BS-R4CC	12-48VDC	-	350/700/1050mA x 4 canales / channels	175x44x30	Receptor RF corriente constante para BS-WIFI / Constant current RF receiver to BS-WIFI



RMC



RMC-VR



RMC-S

REGULADORES MONOCOLOR PWM SINGLE-COLOR PWM REGULATORS



Controladores monocolor manual o vía radio con múltiples funciones de selección de programa y luminosidad. Salida PWM para control de dispositivos LED PWM de 12V o 24V.

Single-color Manual or via radio controllers with multifunctions program selection and lightness. PWM output for PWM LED control devices of 12V or 24V.

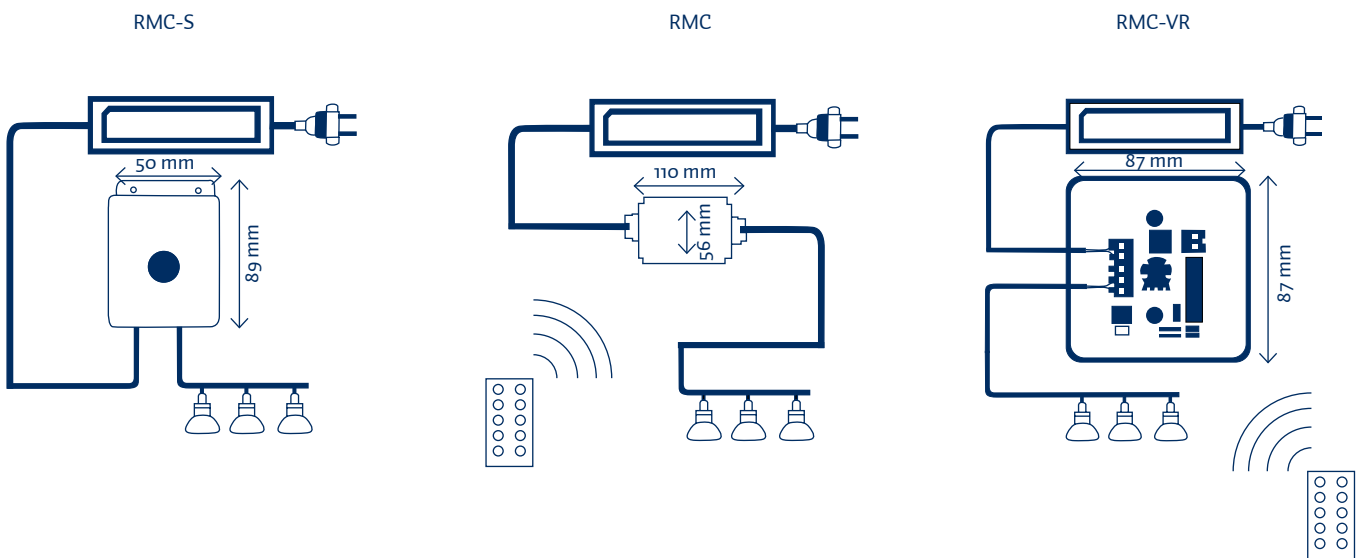

	ALIMENTACIÓN POWER SUPPLY	SALIDA OUTPUT	CARGA MÁX. MAX. CHARGE	MEDIDA MEASURE	COMENTARIO REMARKS
RMC-S	12-24V DC	PWM 12-24V DC	8A	89x50x58mm	Regulador manual / Manual regulator
RMC	12-24V DC	PWM 12-24V DC	8A	110x56x34mm	Regulador vía radio / Regulator via radio
RMC-VR	12-24V DC	PWM 12-24V DC	8A	87x87mm	Regulador manual-infrarojo / Infra-red manual regulator



76
/
77



CONTROL MONOCOLOR MULTIZONA TOUCH SINGLE-COLOR MULTIZONE



Sistema de control monocolor multizona compuesto de mando emisor y receptores. Emisión a 2,4GHz para evitar interferencias. Receptores inalámbricos sin necesidad de cablear entre ellos. Posibilidad de controlar hasta 8 zonas independientemente.

Single-color control system is composed by a transmitter and receiver. It emits 2,4GHz to avoid interferences. Wireless receivers do not need to wire up to each other. Can be possibility to control until 8 independent zones.

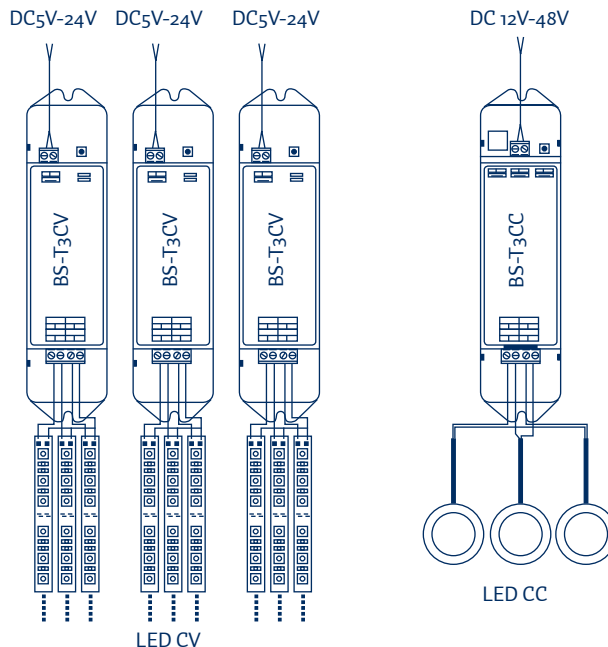
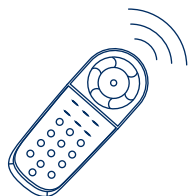
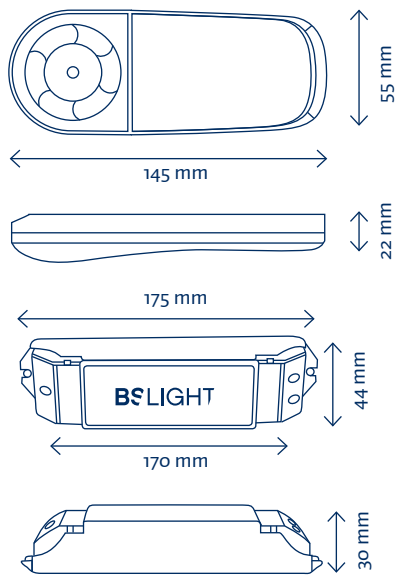

	ALIMENTACIÓN POWER SUPPLY	ZONAS ZONES	CARGA MÁX. MAX.CHARGE	MEDIDAS MEASURE	COMENTARIO REMARKS
BS-T1	batería 5V / Lithium battery	8	-	1145X55X22	Emisor RF para 10 zonas monocolor/ RF transmitter to 10 monocolor zones
BS-T3CV	5-24VDC	-	6A x 3 canales / channels	175X44X30	Receptor tensión constante para BS-T1 / Constant voltage receiver to BS-T1
BS-T3CC	12-48VDC	-	350/700/1050mA x 3 canales / channels	175X44X30	Receptor corriente constante para BS-T1/ Constant current receiver to BS-T1



TMo6E



TMo7E

PANEL TÁCTIL MURAL MONOCOLOR TOUCH SINGLE COLOR PANEL MURAL



Paneles táctiles de instalación mural para el control de equipos monocolor y temperatura de color. Equipos preprogramados con diversos programas de color, luminosidad, temperatura de color... Diseñado para ser integrado e instalado en cajetín europeo empotrado standard en pared.

Touch panel mural installation for controlling single color and color temperature equipment. Teams preset programs with various color, brightness, color temperature ... Designed to be built and installed in standard recessed wall box .

FUENTES Y CONTROLADORES /
DRIVERS AND CONTROLLERS

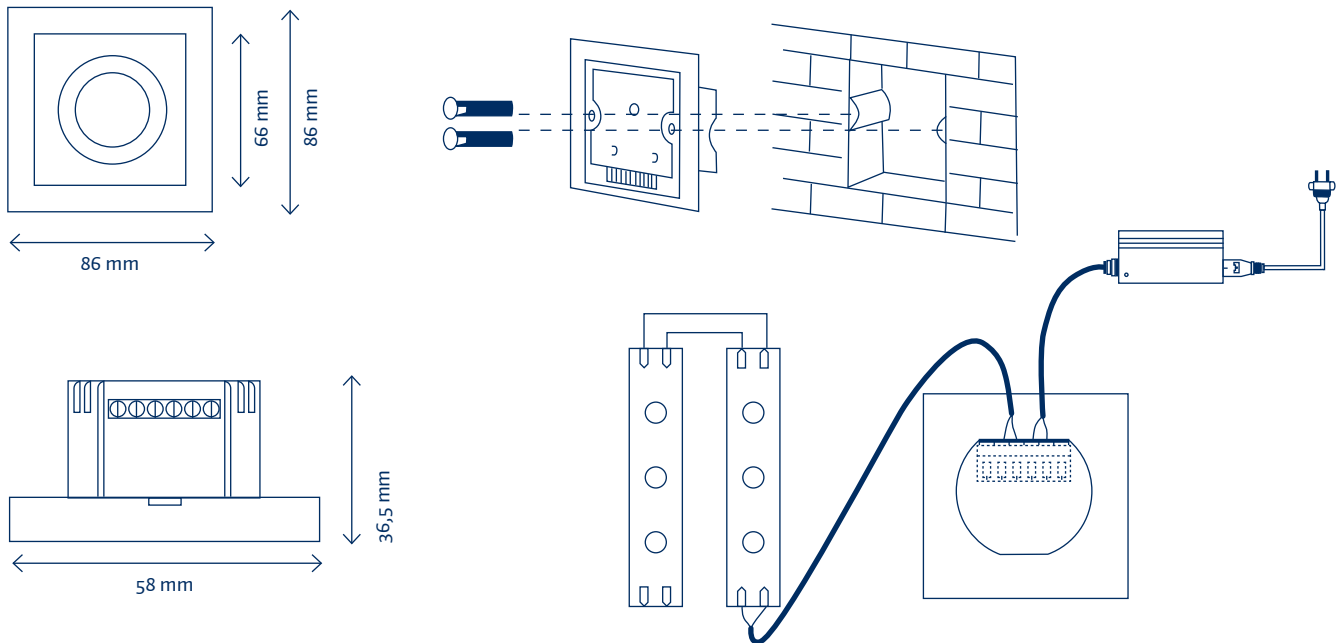

	ALIMENTACIÓN POWER SUPPLY	SALIDA OUTPUT	CARGA MÁX. MAX.CHARGE	MEDIDAS MEASURE	COMENTARIO REMARKS
TMo6E	12-24VDC	1 canal PWM	8A por canal/ channels	80x80x41mm	Regulador monocolor / single-color dimmer
TMo7E	12-24VDC	2 canales PWM	4A por canal/ channels	80x80x41mm	Regulador temperatura de color / Temperature color dimmer

Multizona

RF y DMX

78
/
79



PANEL TÁCTIL MURAL MONOCOLOR RF + DMX

TOUCH PANEL MURAL SINGLE-COLOR + DMX



Sistema de control monocolor compuesto de panel táctil y receptores. Emisión a 2,4GHz para evitar interferencias. Receptores RF inalámbricos sin necesidad de cablear entre ellos. Posibilidad de controlar hasta 4 zonas independientemente. También se puede conectar mediante bus DMX con decodificadores estándar.

RGB control system is composed by a touch panel and receivers. Issued to 2,4GHz to avoid interferences. Wireless receiver RF do not need to wire up each other. They have the possibility to control 4 independent zones and also to connect through a standard bus DMX.

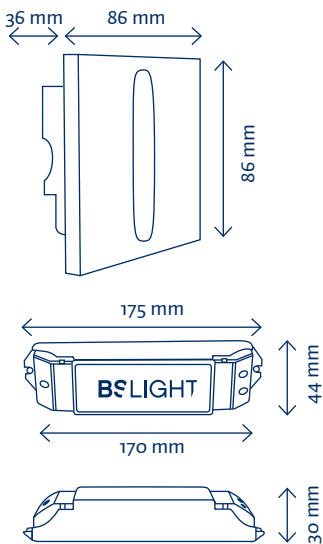

INSTALACIÓN BÁSICA / BASIC INSTALLATION

Sistema RF / RF system

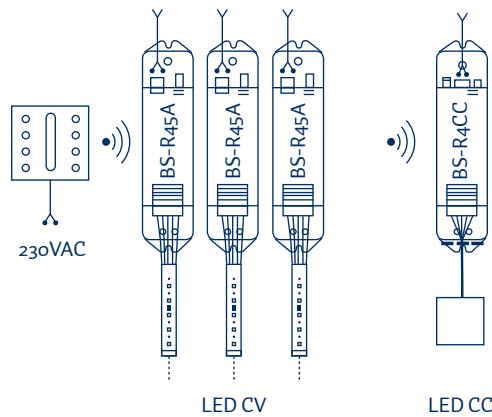

Sistema DMX / DMX system

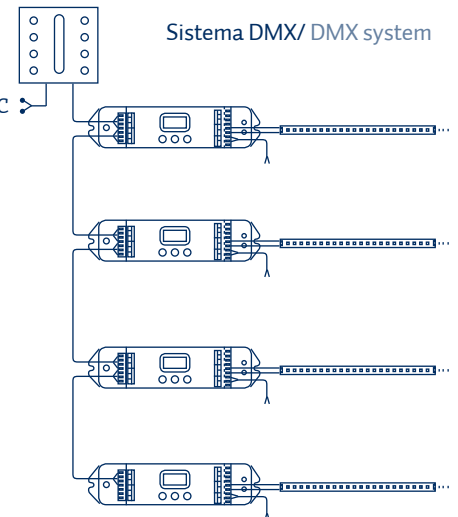

	ALIMENTACIÓN POWER SUPPLY	ZONAS ZONES	CARGA MÁX. MAX.CHARGE	MEDIDAS MEASURE	COMENTARIO REMARKS
BS-DX5	100-230VAC	4	-	145x55x22	Panel RF+DMX para 4 zonas monocolor/ RF panel +DMX for 4 monocolor zones
BS-R45A	5-24VDC	-	5A x 4 canales / channels	175x44x30	Receptor RF tensión constante para BS-DX5 / Constant voltaje RF receiver to BS-DX5
BS-R4CC	12-48VDC	-	350/700/1050mA x 4 canales / channels	175x44x30	Receptor RF corriente constante para BS-DX5 / Constant current RF receiver to BS-DX5

Decodificadores DMX consultar página 84 / DMX decoders see page 84

NOVEDAD



CONTROLADOR PARA LED DIGITAL CSMART/2



CONTROL PARA TIRA LED DIGITAL ,COMPUESTO POR MANDO A DISTANCIA EN R.F. Y RECEPTOR CON 125 PROGRAMAS PRE INSTALADOS PARA CONTROLAR A 2450PIXEL

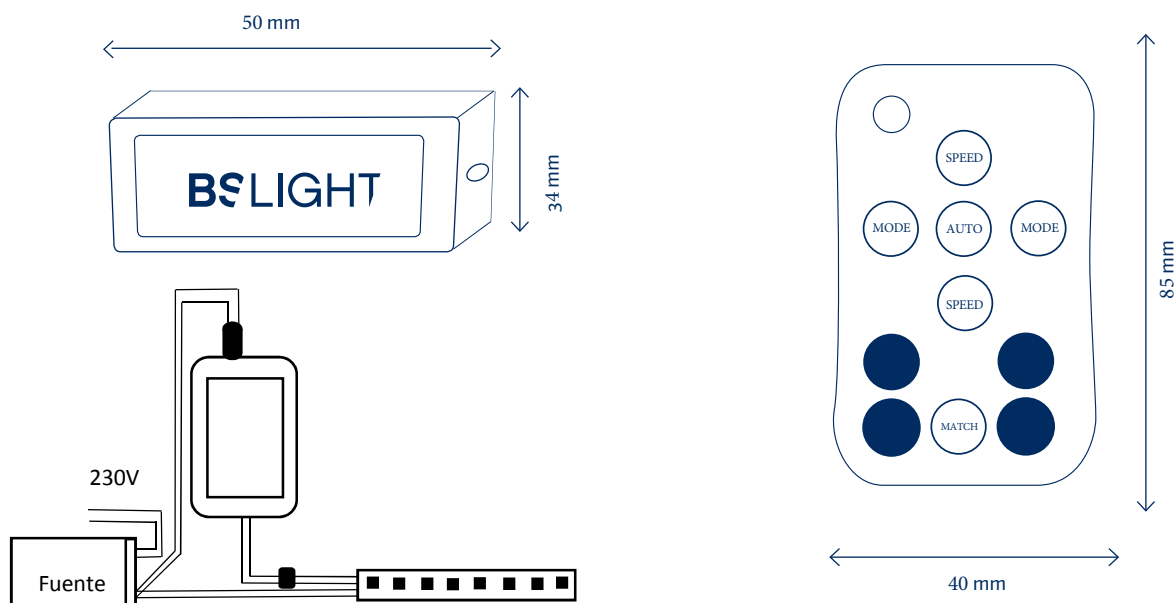

	ALIMENTACIÓN POWER SUPPLY	CARGA MÁX. MAX.CHARGE	MEDIDAS MEASURE	COMENTARIO REMARKS
CSMART/2	Emisor / Remote 5VDC Receptor / Receiver	1 canal		Kit emisor + receptor / remote + receiver



AMPLIFICADOR RGB RGB AMPLIFIER



Amplificador RGB para ampliar las instalaciones con un solo controlador en instalaciones RGB. Amplificador de señal PWM.

RGB Amplifier to extend RGB installations with only one controller. PWM signal amplifier.

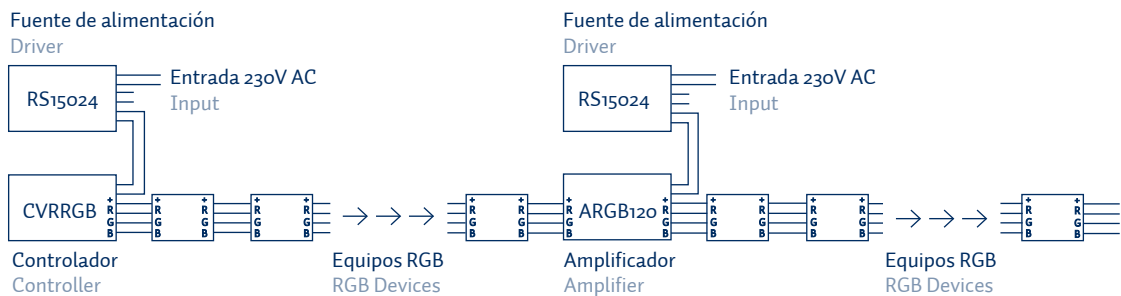

	SEÑAL ENTRADA INPUT SIGNAL	SALIDA OUTPUT	ALIMENTACIÓN POWER SUPPLY	CARGA MÁX. MAX. CHARGE	MEDIDA MEASURE
ARG120-T	PWM 12-24V DC	PWM 12-24V DC	12-24V DC	5A por 3 canales / channels	104x65x24mm



REGULADOR POR TRIAC TRIAC DIMMER



Regulador monocolor para equipos LED que puede ser controlado mediante dimmer estándar con salida triac colocándolo en la entrada de tensión principal.

Single-color LED controller for equipment that can be controlled by standard dimmer with triac output by placing it in the input mains voltage.

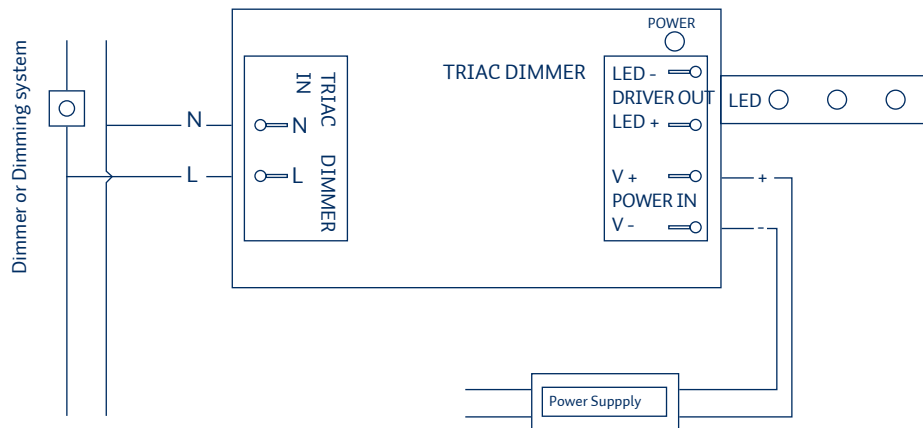
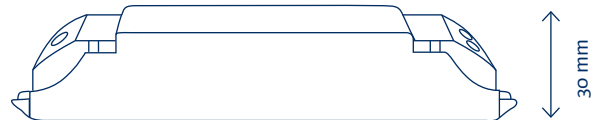
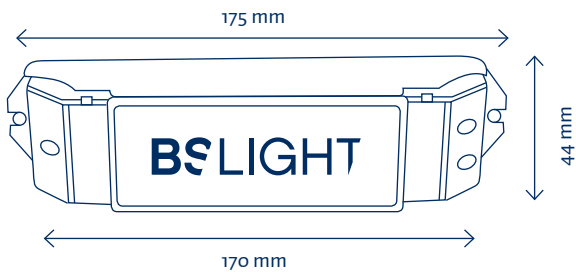

	ALIMENTACIÓN POWER SUPPLY	SALIDA OUTPUT	CARGA MÁX. MAX.CHARGE	MEDIDAS MEASURE	COMENTARIO REMARKS
BS-TRIAC	12-24VDC	1 canal / channel PWM	15A	167x52x24mm	Regulador monocolor triac / Single color triac dimmer



REGULADOR POR PULSADOR PUSH-BUTTON CONTROL



Regulador para equipos LED que puede ser controlado mediante un pulsador estándar, entrada 0/1-10V o potenciómetro.

Dimmer for Led equipment that can be controlled to push-button standard, input 0/1-10V or potentiometer.

FUENTES Y CONTROLADORES /
DRIVERS AND CONTROLLERS

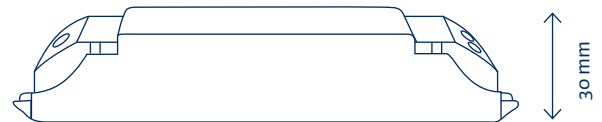
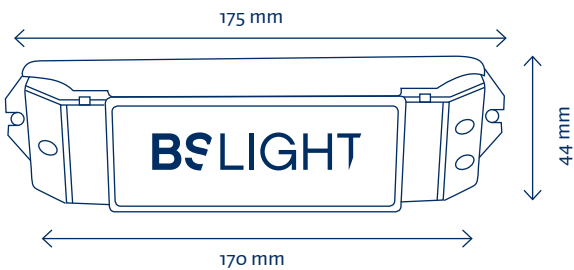

INSTALACIÓN BÁSICA CON PULSADOR / BASIC INSTALLATION WITH PUSH-BUTTON

0/1-10V, 10VPWM,
Resistor Input Socket

Push Button
Connection Socket

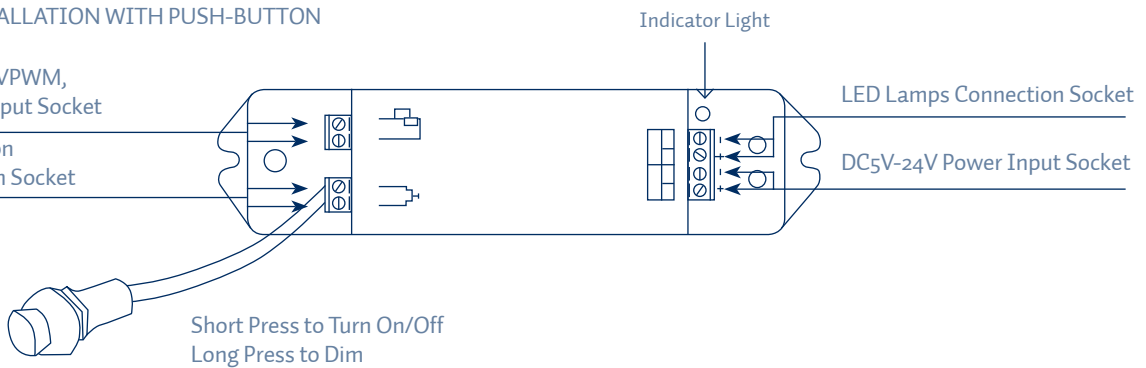

Short Press to Turn On/Off
Long Press to Dim

ALIMENTACIÓN POWER SUPPLY	SALIDA OUTPUT	CARGA MÁX. MAX.CHARGE	MEDIDAS MEASURE	COMENTARIO REMARKS
BS-PUSH-10	5-24VDC	1 canal / channel PWM	10	175x44x30mm Regulador monocolor / Single color dimmer



REGULADORES 0-10V

0-10V DIMMERS



Regulador con entrada para protocolo 0-10V para regulación de equipos LED por tensión PWM 12/24V o por corriente constante 350mA, 700mA y 1050mA.

Dimmers with input for 0-10V protocol to control the LED devices with PWM tension 12/24V or drivers current 350mA, 700mA y 1050mA.

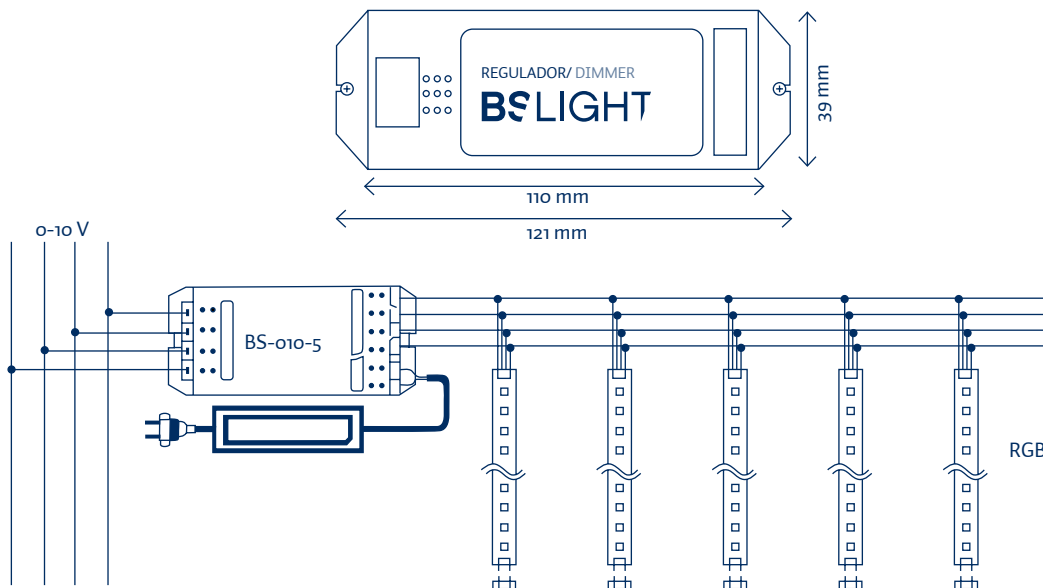

	SEÑAL ENTRADA INPUT SIGNAL	SALIDA OUTPUT	ALIMENTACIÓN POWER SUPPLY	CARGA MÁX. MAX. CHARGE	MEDIDA MEASURE
BS-010-5	Tensión 0-10V	3 canales / channel PWM	12-24V DC	5A / 3 canales / channel	360W (24V) 121x39x39mm
BS-010-10	Tensión 0-10V	1 canal / channel PWM	12-24V DC	10A/1 canal / channel	240W (24V) 121x39x39mm
BS-010-350	Tensión 0-10V	1 canal / channel CC	12-48V DC	350mA CC	1-12 LEDS 1W 121x39x39mm
BS-010-750	Tensión 0-10V	1 canal / channel CC	12-48V DC	700mA CC	1-12 LEDS 3W 121x39x39mm
BS-010-1050	Tensión 0-10V	1 canal / channel CC	12-48V DC	1050mA CC	1-12 LEDS 5W 121x39x39mm



REGULADORES DALI DALI DIMMER



Regulador con entrada para protocolo DALI para regulación de equipos LED por tensión PWM 12/24V o sistema analógico 0-10V.

Dimmer for DALI protocol to control the LED devices with PWM 12/24V or analogue system 0-10V.

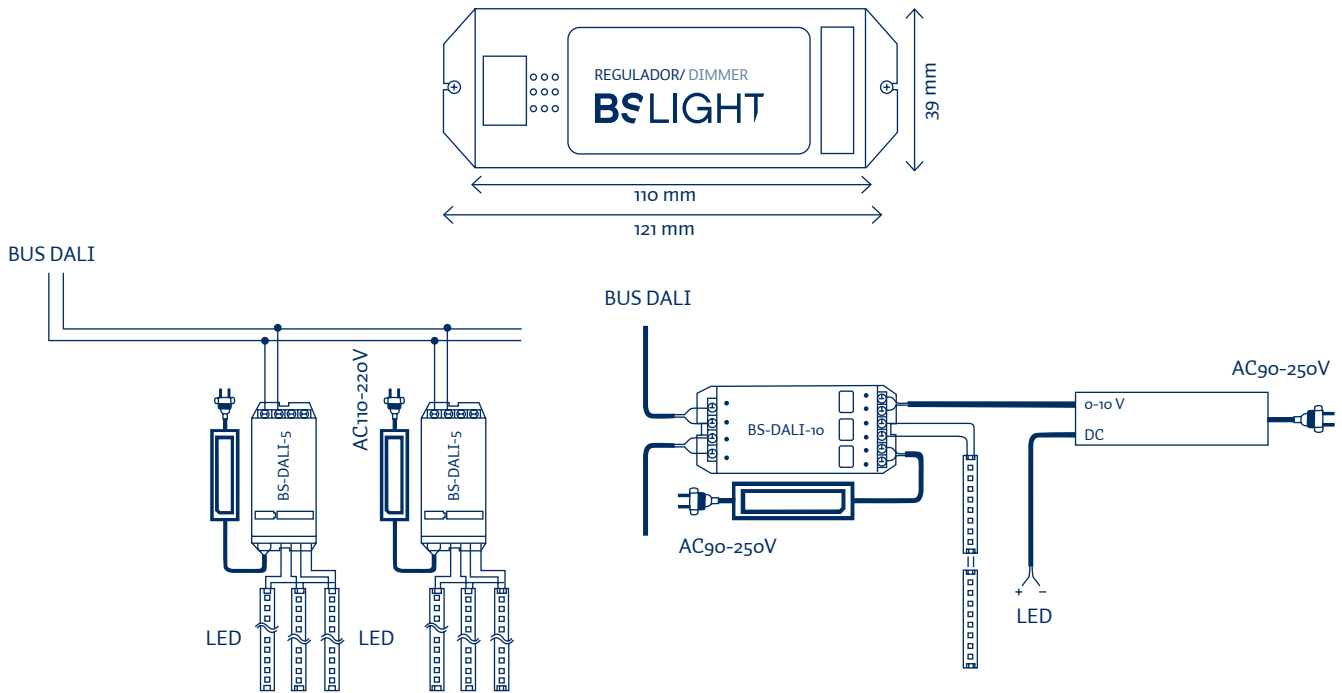

	SEÑAL ENTRADA INPUT SIGNAL	SALIDA OUTPUT	ALIMENTACIÓN POWER SUPPLY	CARGA MÁX. MAX. CHARGE	MEDIDA MEASURE
BS-DALI-5	DALI	PWM 12-24V DC	12-24V DC	5A3 canal / channel	121x39x39mm
BS-DALI-10	DALI	PWM 12-24V DC y 0-10V	12-24V DC	10A canal / channel	121x39x39mm



DECODIFICADOR DMX DMX DECODER



Decodificador con entrada por protocolo DMX y salida PWM para el control de Tiras flexibles, rígidas, bañadores de pared, bombillas... Entrada por conector XLR-3 y RJ45.

DMX decoder with input for protocol and output PWM for the control of flexible or rigid strips, wall washers, bulbs... Input with XLR-3 and RJ45 connectors.

INSTALACIÓN BÁSICA BASIC INSTALLATION

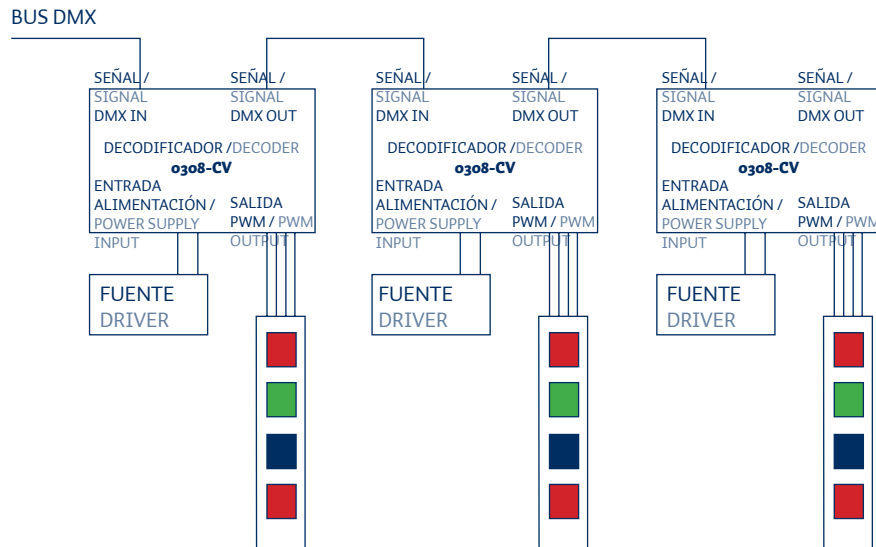

	SEÑAL ENTRADA INPUT SIGNAL	SALIDA OUTPUT	ALIMENTACIÓN POWER SUPPLY	CARGA MÁX. MAX. CHARGE	MEDIDA MEASURE	CONECTORES CONNECTORS
0308CV	DMX512/1990	PWM 12-24V DC	12-24V DC	4A x 3 canales/channels	166x67x41mm	Canon - RJ45
0308CV-4C	DMX512/1990	PWM 12-24V DC	12-48V DC	4A x 4 canales/channels	166x67x41mm	Canon - RJ45
0308CV-350	DMX512/1990	PWM 350mA	12-48V DC	1-12 leds 1W - 3 canales/channels	166x67x41mm	Canon - RJ45
0308CV-700	DMX512/1990	PWM 700mA	12-48V DC	1-12 leds 3W - 3 canales/channels	166x67x41mm	Canon - RJ45
0308CV-010V	DMX512/1990	0-10V	12-48V DC	0-10V - 4 canales/channels	166x67x41mm	Canon - RJ45

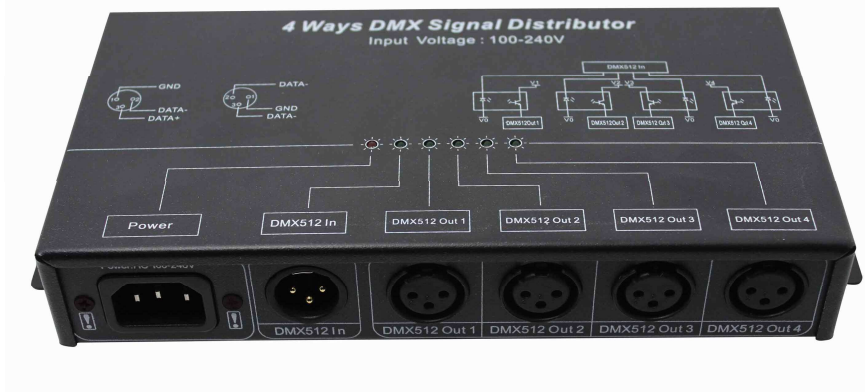

DISTRIBUIDOR SEÑAL DMX 4 PUERTOS



El distribuidor de la señal de DMX , se utiliza especialmente para amplificar la señal digital del control de la iluminación DMX512 con 4 salidas amplificadas.

The DMX Signal Distributor, is specially used to amplify DMX512 digital lighting control signal with 4 amplified outputs.

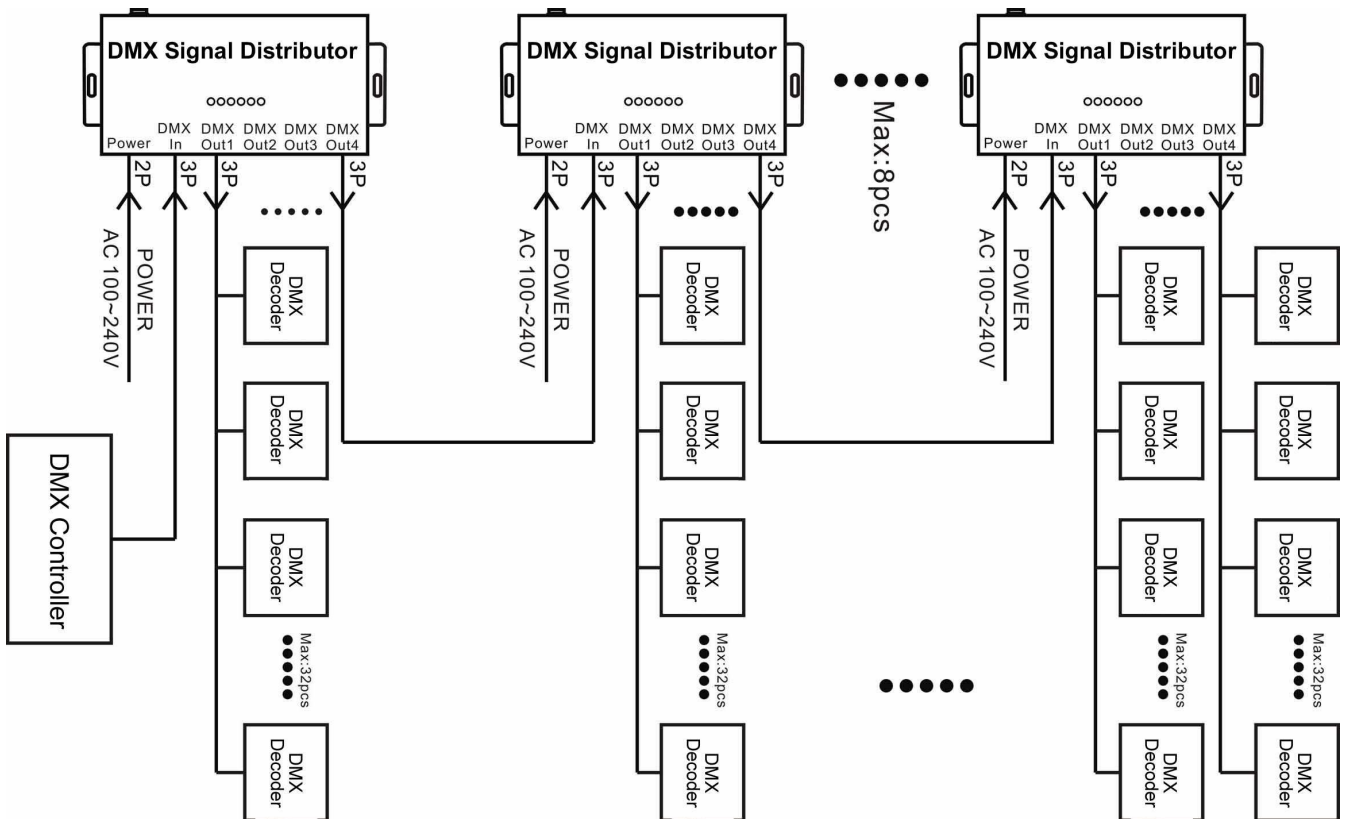

	SEÑAL ENTRADA INPUT SIGNAL	SALIDA OUTPUT	ALIMENTACIÓN POWER SUPPLY	CARGA MÁX. MAX. CHARGE	MEDIDA MEASURE	CONECTORES CONNECTORS
SPDMX4/2	DMX512/1990	DMX512/1990	100-230V AC	32 PIEZAS/POR SALIDA	241x34,50x109,50mm	Canon -XLR



DMX
Inalám-
brico

TRANSMISOR DMX INALÁMBRICO

DMX WIRELESS TRANSMITTER



Transmisor DMX inalámbrico que se puede configurar como emisor o receptor. Puede transmitir la señal DMX hasta 350m de distancia. Máximo 64 canales de transmisión.

DMX wireless transmitter that can be configured as a transmitter or receiver. It can transmit the DMX signal up to 350m away. Maximum 64 transmission channels.

FUENTES Y CONTROLADORES /
DRIVERS AND CONTROLLERS



DIAGRAMA BÁSICO DE INSTALACIÓN DMX INALÁMBRICO
BASIC INSTALLATION TO DMX WIRELESS



	SEÑAL ENTRADA INPUT SIGNAL	ALIMENTACIÓN POWER SUPPLY	TRANSMISIÓN SEÑAL SIGNAL TRANSMISSION	MEDIDAS MEASURE	CONECTORES CONNECTORS
BS-LT870	DMX	5-24VDC	2,4GHz	175x44x30mm	Regleta de bornes / Terminal plate

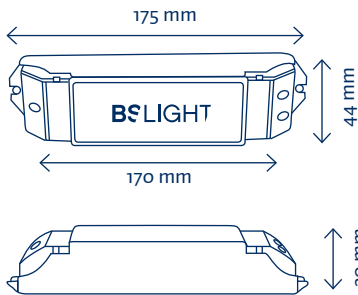
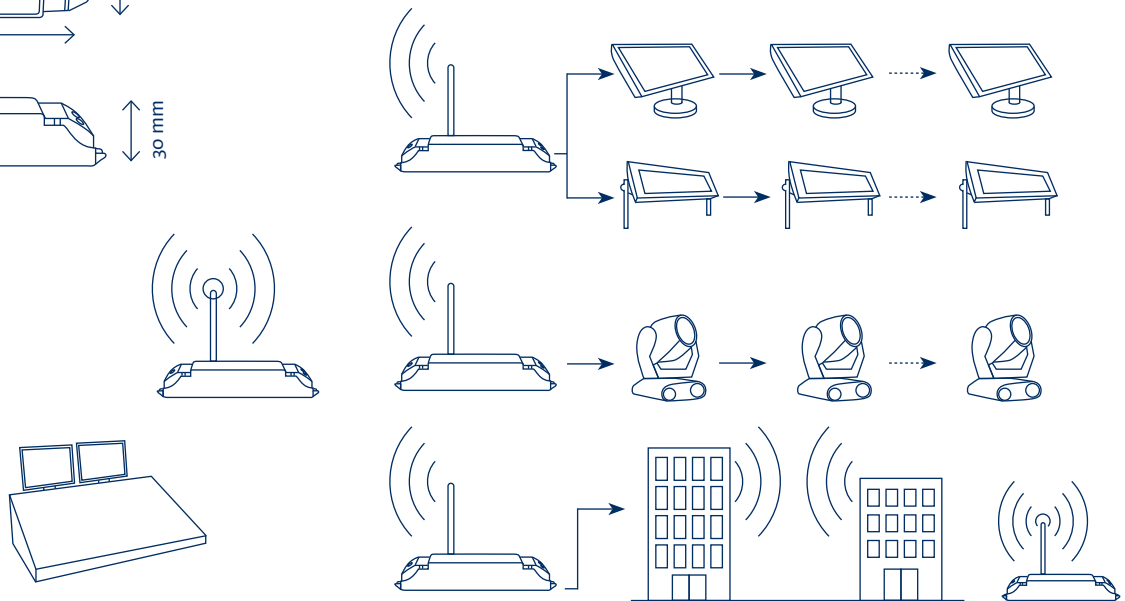

INTERFACE USB-DMX USB-DMX INTERFACE



Interface USB a DMX que convierte la señal proveniente del USB del PC al protocolo DMX512. Se entrega con drivers y programa de gestión. Mediante el software incluido, se puede programar en el PC las escenas que queremos crear. DXPACK01 debe conectarse permanentemente al PC para generar el programa, DXPACKU6 puede funcionar de forma autónoma.

USB-DMX interface that converts the USB signal from the PC to the protocol DMX512. Drivers and control software included. Using the software, the sequences can be programmed in the PC. To operate the program, the DXPACK01 must be continuously connected to the PC whereas the DXPACKU6 is stand-alone and can work independently.

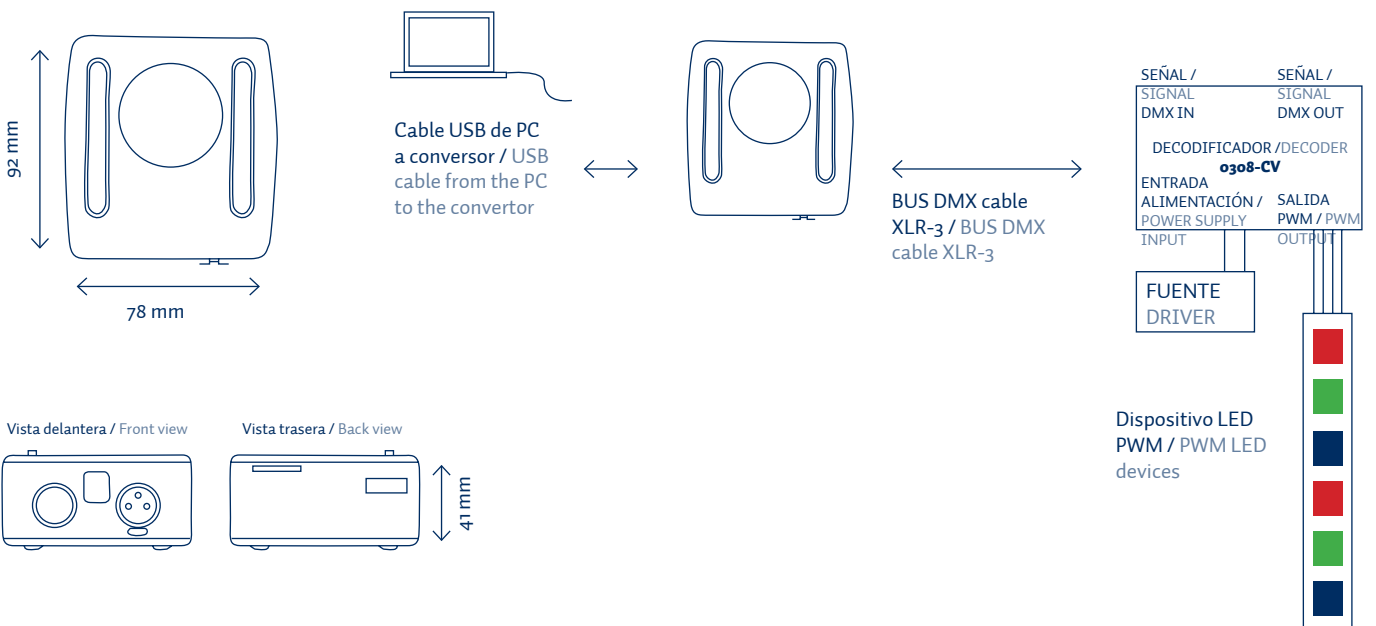

CARACTERÍSTICAS - MEMORIA CHARACTERISTICS - MEMORY

ACCESORIOS ACCESSORIES

DXPACK01	Live mode. Conexión permanente a PC / Live mode. Continuous connection to the PC	Cable, manual, drivers y programa / Wire, instructions, drivers and software
DXPACKU6	5K. 128 canales. 20 escenas / 5K. 128 channels. 20 sequences	Cable, manual, drivers y programa / Wire, instructions, drivers and software



INTERFACE USB-DMX PANEL TÁCTIL

TOUCH PANEL USB-DMX INTERFACE



Interface USB a DMX con panel táctil para instalar en pared que convierte la señal proveniente del USB del PC al protocolo DMX512. Se entrega con drivers y programa de gestión. Mediante el software incluido, se puede programar en el PC las escenas que queremos crear.

USB-DMX interface with touch panel to be fixed on the wall. Convert the USB signal from the PC to the protocol DMX512. Drivers and control software included. Using the software, the sequences can be programmed in the PC.

FUENTES Y CONTROLADORES / DRIVERS AND CONTROLLERS

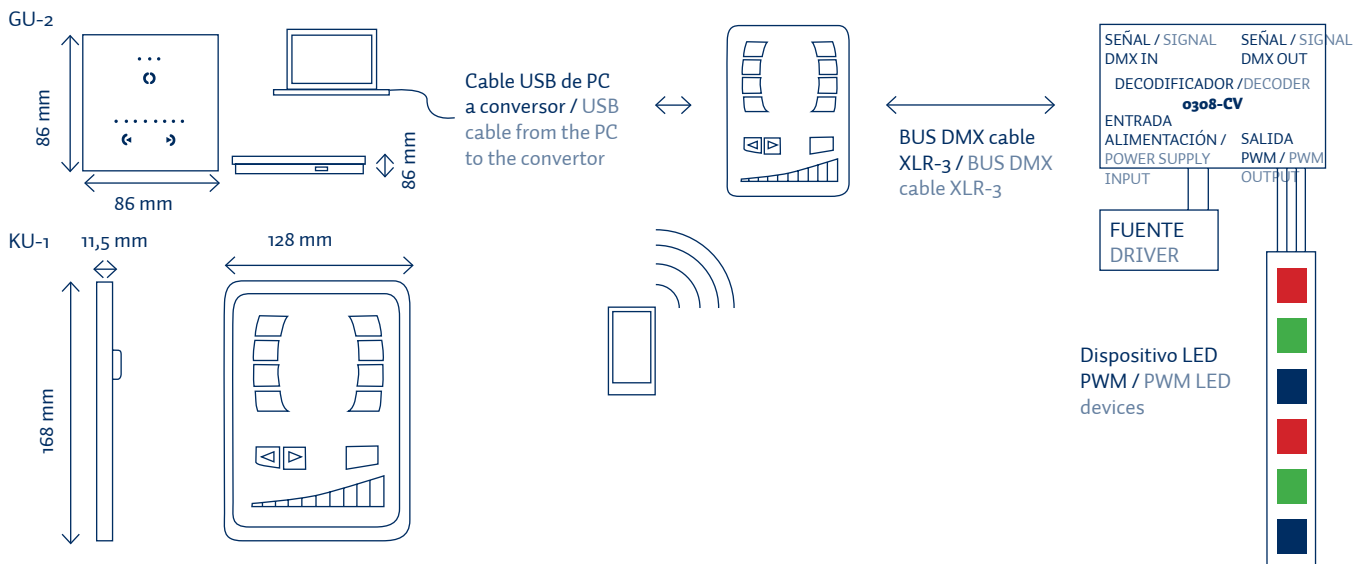

CARACTERÍSTICAS - MEMORIA

CHARACTERISTICS - MEMORY

ACCESORIOS

ACCESSORIES

KU-1	Micro SD. 1024 canales. 200 escenas. 5 zonas / Micro SD. 1024 channels. 200 sequences. 5 zones	Cable, manual, drivers y programa / Wire, instructions, drivers and software
GU-2	5K. 128 canales. 24 escenas / 5K. 128 channels. 24 sequences	Cable, manual, drivers y programa / Wire, instructions, drivers and software



SENSORES DE PRESENCIA Y CONTACTO PRESENCE AND CONTACT SENSORS



Sensores de presencia y contacto para el encendido y apagado de los equipos conectados a la salida.

Presence and contact sensors to switch ON and OFF the devices connected to the output.

EJEMPLO FUNCIÓN HZKB250-J / FUNCTION EXAMPLE HZKB250-J

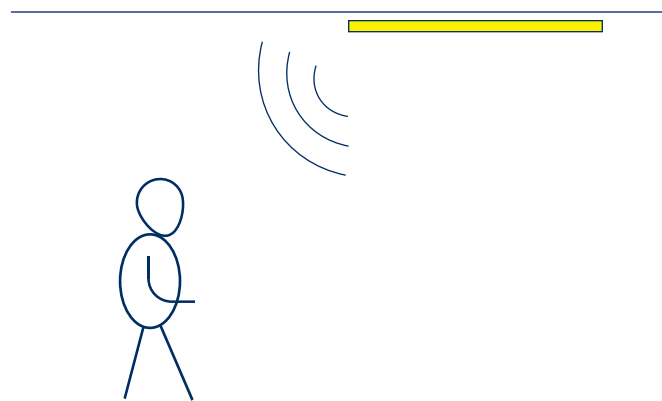
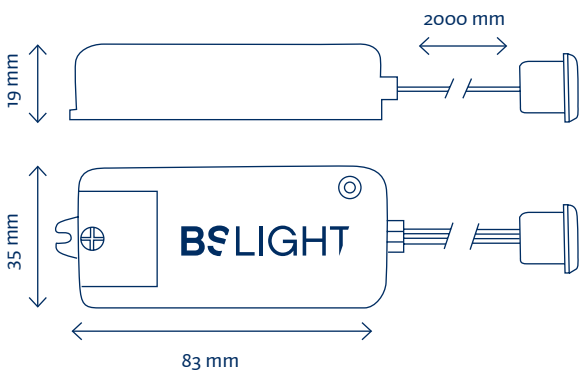

	CARACTERÍSTICAS - MEMORIA CHARACTERISTICS - MEMORY	POTENCIA MÁX MAX POWER	ENTRADA INPUT	DETECCIÓN DETECTION
HZHB250-J	Sensor de presencia PIR / Presence sensor PIR	250W	100-240V AC	2,50 mts
HZK218B	Sensor de presencia IR tipo pulsador (monoestable) / Presence sensor push button model (monostable)	250W	100-240V AC	5-10 cm
HZK218C	Sensor de presencia IR tipo interruptor (biestable) / Presence sensor switch model (bistable)	250W	100-240V AC	5-10 cm
HZK201	Sensor de contacto / Contact sensor	250W	100-240V AC	Al tacto / touch

“El control de la
iluminación es el futuro.
Confíe en BSLIGHT para
sus proyectos”

“The lighting control is the
future. Trust BSLIGHT for
your projects”

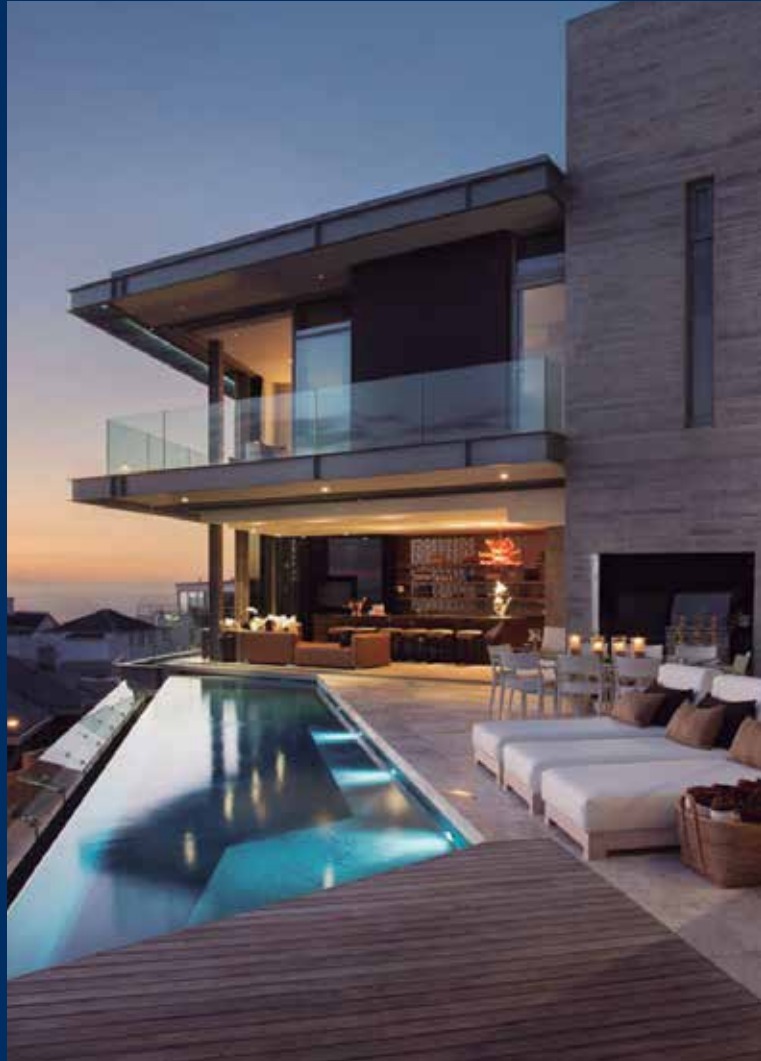

ILUMINACIÓN EXTERIOR

04

OUTDOOR
LIGHTING



EMPOTRABLE DE SUELO 55mm RECESSED INGROUND 55MM



Empotrable de suelo de diámetro 55 mm con haz de luz simétrico o asimétrico. Fabricado con cuerpo y embellecedor de acero 316. Cristal templado de 8 mm. Incluye carcasa empotrable para su instalación si se precisa. Para el funcionamiento de los equipos RGB será preciso un controlador tipo PWM.

Recessed inground with 55 mm diameter symmetrical or asymmetrical beam. Made with steel section and trim 316. 8 mm tempered glass. Includes recessed housing for installation if required. For RGB equipment will require a PWM type controller.

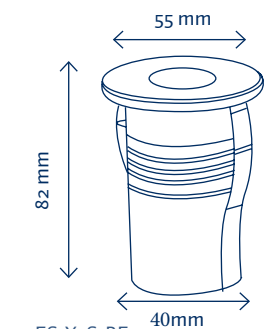

ÁNGULO SIMÉTRICO
SYMETRIC ANGLE

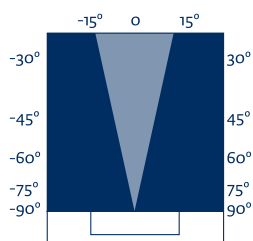

ÁNGULO ASIMÉTRICO
ASYMETRIC ANGLE

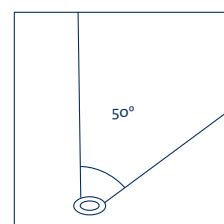
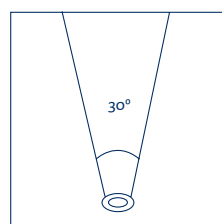

ES1X2S-BF

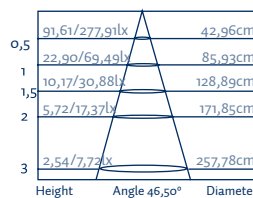
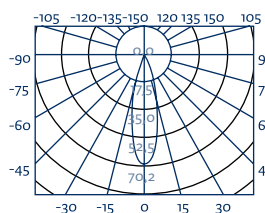

ES1X2A-BF

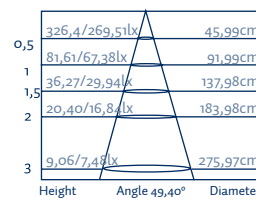
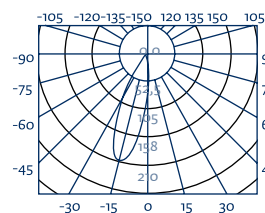

	COLOR COLOR	TEMP. TEMP.	ALIMENTACIÓN POWER SUPPLY	PROTECCIÓN PROTECTION	TIPO DE LED LED TYPE	FLUJO LUM. LUM. FLOW	ÁNGULO ANGLE	CONSUMO CONSUME
ES1X2S-BF		6000°K	220-240V AC	IP67	1 LEDS 2W Cree	77lm	Symmetric 30°	4W
ES1X2S-BC		3000°K	220-240V AC	IP67	1 LEDS 2W Cree	65lm	Symmetric 30°	4W
ES1X2S-RGB		RGB	24V DC	IP67	1 LEDS 2W Cree	R12/G29/B8	Symmetric 30°	5W
ES1X2A-BF		6000°K	220-240V AC	IP67	1 LEDS 2W Cree	77lm	Asymmetric 50-35°	4W
ES1X2A-BC		3000°K	220-240V AC	IP67	1 LEDS 2W Cree	65lm	Asymmetric 50-35°	4W
ES1X2A-RGB		RGB	24V DC	IP67	1 LEDS 2W Cree	R12/G29/B8	Asymmetric 50-35°	5W



EMPOTRABLE DE SUELO 116MM RECESSED INGROUND 116MM



Empotrable de suelo de diámetro 116mm con haz de luz simétrico o asimétrico. Fabricado con cuerpo y embellecedor de acero 316. Cristal templado de 8mm. Incluye carcasa empotrable para su instalación si se precisa. Para el funcionamiento de los equipos RGB será preciso un controlador tipo PWM.

Recessed inground with 116mm diameter symmetrical or asymmetrical beam. Made with steel section and trim 316. 8mm tempered glass. Includes recessed housing for installation if required. For RGB equipment will require a PWM type controller.

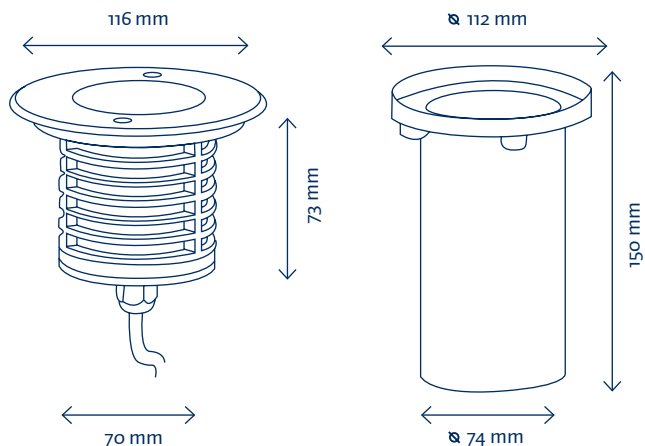

ES₃x2S-BF

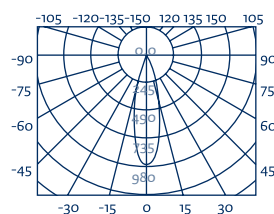

Height	Angle 56,10°	Diameter
0,5	309,1/1027lx	53,28cm
1	77,28/256,7lx	106,57cm
1,5	34,34/114lx	159,85cm
2	19,32/64,18lx	213,13cm
3	8,58/28,92lx	319,70cm

ES₃x2S-BC

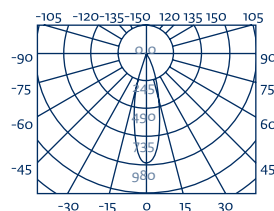

Height	Angle 37,10°	Diameter
0,5	1422/3881lx	33,56cm
1	355,3/970,3lx	67,11cm
1,5	157,9/431,2lx	100,67cm
2	88,84/242,1lx	134,23cm
3	39,48/107,8lx	201,34cm

	COLOR COLOR	TEMP. TEMP.	ALIMENTACIÓN POWER SUPPLY	PROTECCIÓN PROTECTION	TIPO DE LED LED TYPE	FLUJO LUM. LUM. FLOW	ÁNGULO ANGLE	CONSUMO CONSUME
ES ₃ X2S-BF		6000°K	220-240V AC	IP67	3 LEDS 2W Cree	347lm	Symmetric 22°	8W
ES ₃ X2S-BC		3000°K	220-240V AC	IP67	3 LEDS 2W Cree	300lm	Symmetric 22°	8W
ES ₃ X2S-RGB		RGB	24V DC	IP67	3 LEDS 2W Cree	R48/G79/B20	Symmetric 20°	10W
ES ₃ X2A-BF		6000°K	220-240V AC	IP67	3 LEDS 2W Cree	338lm	Asymmetric 45-35°	8W
ES ₃ X2A-BC		3000°K	220-240V AC	IP67	3 LEDS 2W Cree	286lm	Asymmetric 45-35°	8W
ES ₃ X2A-RGB		RGB	24V DC	IP67	3 LEDS 2W Cree	R48/G79/B20	Asymmetric 50-35°	10W



EMPOTRABLE DE SUELO 173MM RECESSED INGROUND 173MM



Empotrable de suelo de diámetro 116mm con haz de luz simétrico o asimétrico. Fabricado con cuerpo y embellecedor de acero 316. Cristal templado de 8mm. Incluye carcasa empotrable para su instalación si se precisa. Para el funcionamiento de los equipos RGB será preciso un controlador tipo PWM.

Recessed inground with 173mm diameter symmetrical or asymmetrical beam. Made with steel section and trim 316. 8mm tempered glass. Includes recessed housing for installation if required. For RGB equipment will require a PWM type controller.

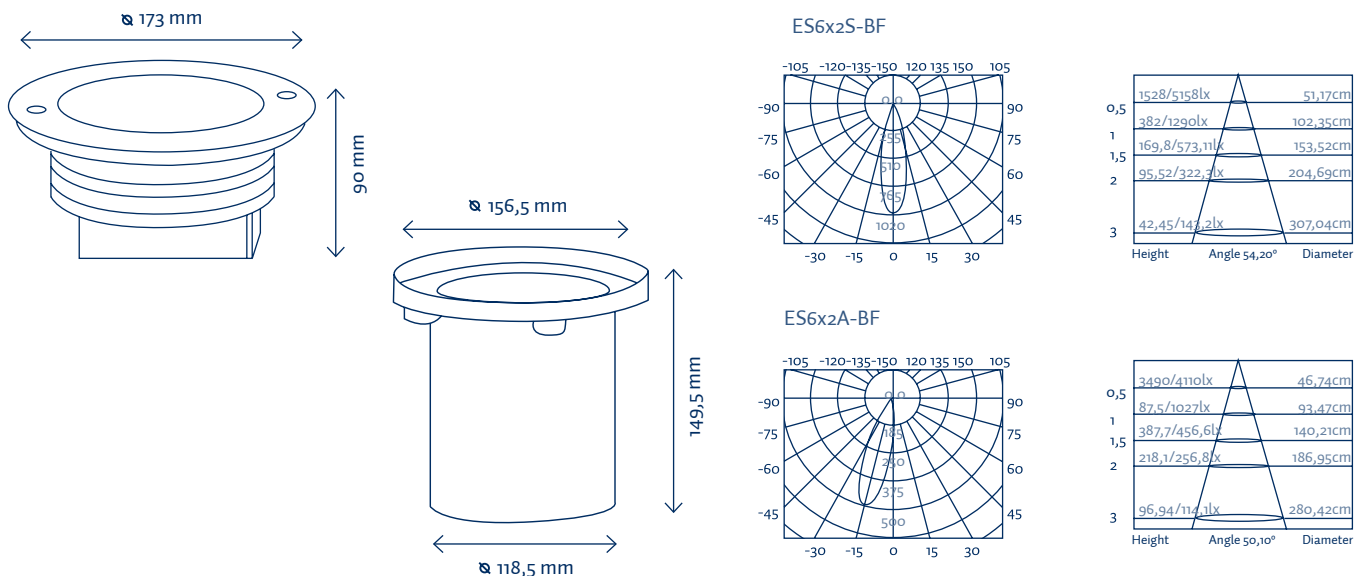

	COLOR COLOR	TEMP. TEMP.	ALIMENTACIÓN POWER SUPPLY	PROTECCIÓN PROTECTION	TIPO DE LED LED TYPE	FLUJO LUM. LUM. FLOW	ÁNGULO ANGLE	CONSUMO CONSUME
ES6X2S-BF		6000°K	220-240V AC	IP67	6 LEDS 2W Cree	528lm	Symmetric 20°	8W
ES6X2S-BC		3000°K	220-240V AC	IP67	6 LEDS 2W Cree	455lm	Symmetric 20°	8W
ES6X2S-RGB		RGB	24V DC	IP67	6 LEDS 2W Cree	R100/G155/B45	Symmetric 20°	10W
ES6X2A-BF		6000°K	220-240V AC	IP67	6 LEDS 2W Cree	590lm	Asymmetric 45-35°	8W
ES6X2A-BC		3000°K	220-240V AC	IP67	6 LEDS 2W Cree	510lm	Asymmetric 45-35°	8W
ES6X2A-RGB		RGB	24V DC	IP67	6 LEDS 2W Cree	R100/G155/B45	Asymmetric 50-35°	10W



PIQUETAS DE JARDÍN GARDEN SPIKES



Piquetas de exterior fabricado en aluminio con acabado anodizado. Montada con óptica en ángulo de 22-30°. Para el funcionamiento de los equipos RGB será preciso un controlador tipo PWM.

Outer spikes made in aluminum with anodized finish. Mounted with optical angle of 30°. For RGB equipment will require a CVRRGB type PWM.

PQ1X3

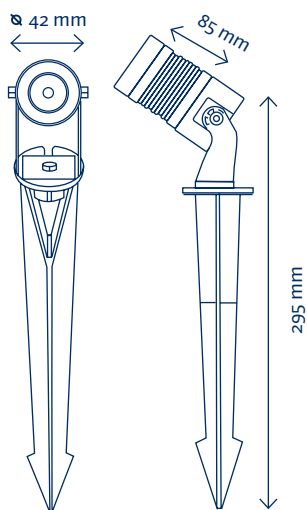

PQ3X2

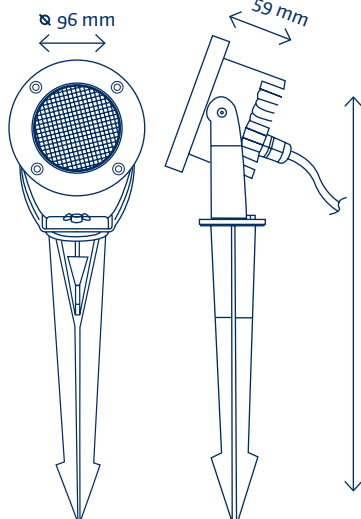

PQ1X3-BF

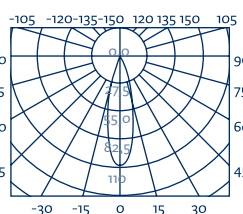

Height	Angle 48,80°	Diameter
0,5	141,2/429,4lx	45,36cm
1	35,31/107,3lx	90,72cm
1,5	15,69/43,71lx	136,09cm
2	8,82/26,84lx	181,45cm
3	3,93/11,82lx	272,17cm

PQ3X2-BF

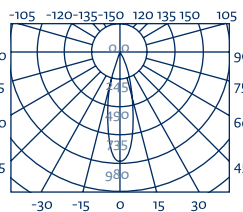

Height	Angle 56,10°	Diameter
0,5	309,1/1027lx	53,28cm
1	77,28/256,7lx	106,57cm
1,5	34,34/114,0lx	159,85cm
2	19,32/64,18lx	213,13cm
3	8,58/28,32lx	319,70cm

	COLOR COLOR	TEMP. TEMP.	ALIMENTACIÓN POWER SUPPLY	PROTECCIÓN PROTECTION	TIPO DE LED LED TYPE	FLUJO LUM. LUM. FLOW	ÁNGULO ANGLE	CONSUMO CONSUME
PQ1X3-BF		6000°K	220-240V AC	IP65	1 LEDS 3W	95lm	Symmetric 30°	4W
PQ1X3-BC		3000°K	220-240V AC	IP65	1 LEDS 3W	81lm	Symmetric 30°	4W
PQ1X3-RGB		RGB	24V DC	IP65	1 LEDS 3W	R18/G26/B6	Symmetric 30°	5W
PQ3X2-BF		6000°K	220-240V AC	IP65	3 LEDS 2W	224lm	Symmetric 22°	8W
PQ3X2-BC		3000°K	220-240V AC	IP65	3 LEDS 2W	198lm	Symmetric 22°	8W
PQ3X2-RGB		RGB	24V DC	IP65	3 LEDS 2W	R70/G113/B31	Symmetric 20°	12W



PROYECTORES DE JARDÍN GARDEN SPOTLIGHT



Pequeños proyectores de exterior fabricados en aluminio con acabado anodizado. Montada con óptica en ángulo de 30°. Para el funcionamiento de los equipos RGB será preciso un controlador tipo PWM.

Small outdoor spotlight made of anodized aluminum. Mounted with optical angle of 30°. RGB (4 wire) control will require PWM driver.

PY1X3

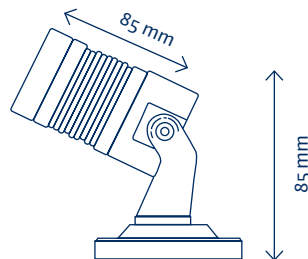
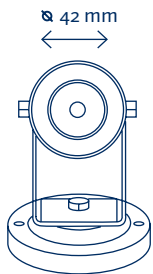

PY3X2

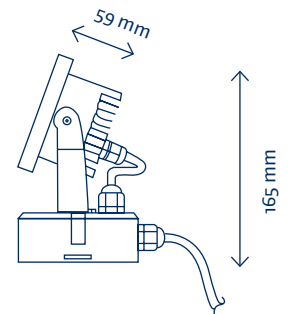
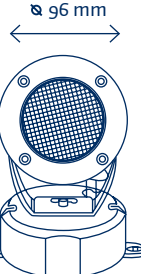

PY1X3-BF

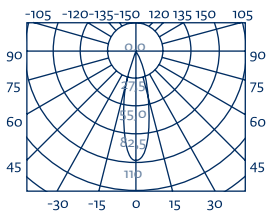

Height	Angle 48,80°	Diameter
0,5	141,2/429,4lx	45,36cm
1	35,31/107,3lx	90,72cm
1,5	15,69/43,7lx	136,09cm
2	8,828/26,8lx	181,45cm
3	3,933/11,8lx	272,17cm

PY3X2-BF

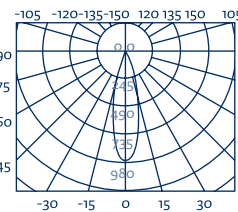

Height	Angle 56,10°	Diameter
0,5	309,1/1027lx	53,28cm
1	77,28/256,7lx	106,57cm
1,5	34,34/114,0lx	159,85cm
2	19,32/64,18lx	213,13cm
3	8,58/28,5lx	319,70cm

	COLOR COLOR	TEMP. TEMP.	ALIMENTACIÓN POWER SUPPLY	PROTECCIÓN PROTECTION	TIPO DE LED LED TYPE	FLUJO LUM. LUM. FLOW	ÁNGULO ANGLE	CONSUMO CONSUME
PY1X3-BF		6000°K	220-240V AC	IP65	1 LEDS 3W	95lm	Symmetric 30°	4W
PY1X3-BC		3000°K	220-240V AC	IP65	1 LEDS 3W	81lm	Symmetric 30°	4W
PY1X3-RGB		RGB	24V DC	IP65	1 LEDS 3W	R18/G26/B6	Symmetric 30°	5W
PY3X2-BF		6000°K	220-240V AC	IP65	3 LEDS 2W	224lm	Symmetric 22°	8W
PY3X2-BC		3000°K	220-240V AC	IP65	3 LEDS 2W	198lm	Symmetric 22°	8W
PY3X2-RGB		RGB	24V DC	IP65	3 LEDS 2W	R70/G113/B31	Symmetric 20°	12W



PROYECTORES DE ALTA POTENCIA HIGH POWER OUTDOOR SPOTLIGHT



Proyector de exterior de alta potencia fabricados en aluminio con acabado anodizado. Montada con óptica en ángulo desde 6° a 30°. Para el funcionamiento de los equipos RGB será preciso un controlador tipo PWM.

High power outdoor floodlight made of aluminum with anodized finish. Mounted with optical angle from 6° to 30°. RGB (4 wire) control will require PWM driver.

PY6X2

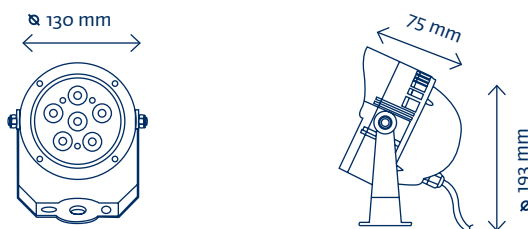

PY12X2

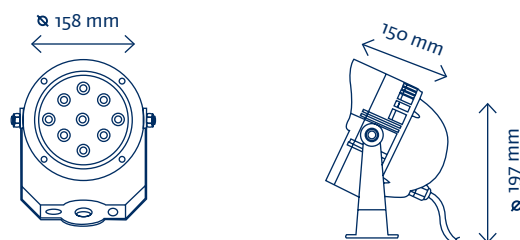

PY6X2-BF

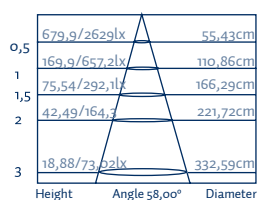
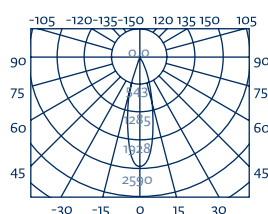

PY12X2

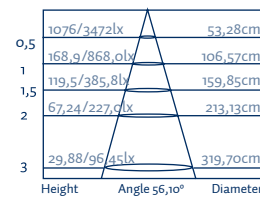
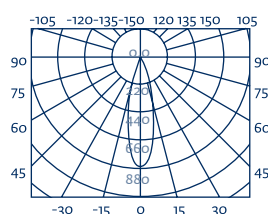

	COLOR COLOR	TEMP. TEMP.	ALIMENTACIÓN POWER SUPPLY	PROTECCIÓN PROTECTION	TIPO DE LED LED TYPE	FLUJO LUM. LUM. FLOW	ÁNGULO ANGLE	CONSUMO CONSUME
PY6X2-BF		6000°K	220-240V AC	IP65	6 LEDS2W	605lm	6°-13°-20°-30°	15W
PY6X2-BC		3000°K	220-240V AC	IP65	6 LEDS 2W	525lm	6°-13°-20°-30°	15W
PY6X2-RGB		RGB	24V DC	IP65	6 LEDS 2W	R100/G155/B20	15°-30°	15W
PY12X2-BF		6000°K	220-240V AC	IP65	12 LEDS 2W	950lm	6°-13°-20°-30°	30W
PY12X2-BC		3000°K	220-240V AC	IP65	12 LEDS 2W	810lm	6°-13°-20°-30°	30W
PY12X2-RGB		RGB	24V DC	IP65	12 LEDS 2W	R210/G315/B92	15°-30°	30W



BAÑADOR DE PARED WALL WASHER



Bañador de pared de 500 y 1000mm de longitud de 18 y 36 LEDs respectivamente. Carcasa de aluminio de alto impacto con estanqueidad IP65 para su aplicación en exteriores para iluminar fachadas. Incluye escuadras de fijación a pared. Para el funcionamiento de los equipos RGB será preciso un controlador tipo PWM.

Wall washer 500 and 1000mm in length from 18 and 36 LEDs respectively. Aluminum housing with high impact IP65 for outdoor use to illuminate facades. Include wall mounting brackets. RGB (4 wire) control will require PWM driver.

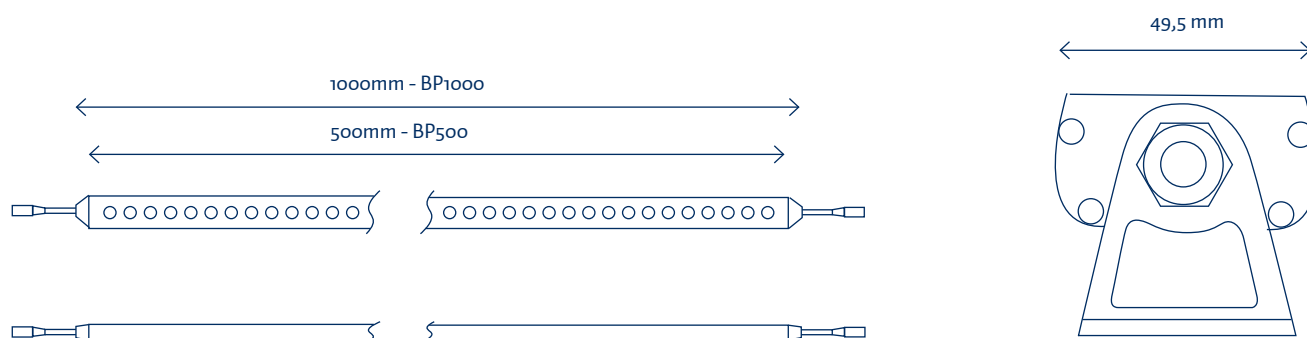

	COLOR COLOR	TEMP. TEMP.	ALIMENTACIÓN POWER SUPPLY	MEDIDAS DIMENSIONS	TIPO DE LED LED TYPE	FLUJO LUM. LUM. FLOW	ÁNGULO ANGLE	CONSUMO CONSUME
BP500B		6000°K	24V DC	500x53x70mm	18 LEDs 1W HP	1600lm	25-45°	24W
BP1000B		6000°K	24V DC	1000x53x70mm	36 LEDs 1W HP	3200lm	25-45°	48W
BP500BC		3000°K	24V DC	500x53x70mm	18 LEDs 1W HP	1600lm	25-45°	24W
BP1000BC		3000°K	24V DC	1000x53x70mm	36 LEDs 1W HP	3200lm	25-45°	48W
BP500RGB		RGB	24V DC	500x53x70mm	18 LEDs 1W HP	R375/G580/B175	25-45°	24W
BP1000RGB		RGB	24V DC	1000x53x70mm	36 LEDs 1W HP	R750/G1160/B350	25-45°	48W



EMPOTRABLE SUMERGIBLE 67mm WATERPROOF RECESSED 67mm



Empotrable sumergible de diámetro 67,5mm con haz de luz simétrico o asimétrico. Fabricado con cuerpo y embellecedor de acero 316. Cristal templado de 8mm. Incluye nicho empotrable para su instalación. Para el funcionamiento de los equipos RGB (4 cables) será preciso un controlador tipo PWM. Instalación ideal para piscinas, estanques...

Waterproof recessed 67,5mm diameter with symmetrical or asymmetrical light beam. Made with steel section 316. 8mm tempered glass. Installation recessed enclosed. For RGB (4 wire) equipment will require PWM controller type. Ideal for pools, ponds ...

Luminaria / Spotlight

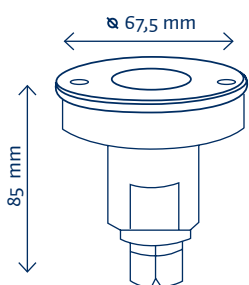

Instalación / Installation

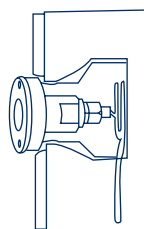
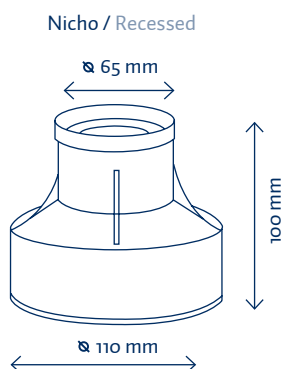

ESS1x3S-BF

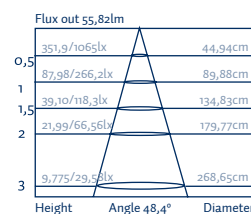
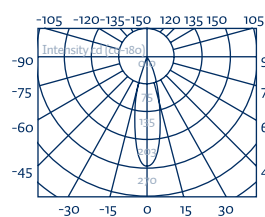

ESS1x3A-BF

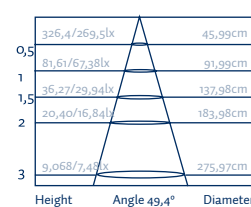
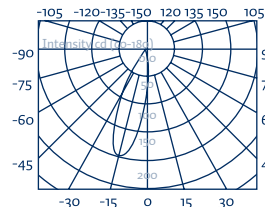

	COLOR COLOR	TEMP. TEMP.	ALIMENTACIÓN POWER SUPPLY	PROTECCIÓN PROTECTION	TIPO DE LED LED TYPE	FLUJO LUM. LUM. FLOW	ÁNGULO ANGLE	CONSUMO CONSUME
ESS1X3S-BF		6000°K	24V DC	IP68	1 LEDS 3W	67lm	Symmetric 30°	5W
ESS1X3S-BC		3000°K	24V DC	IP68	1 LEDS 3W	57lm	Symmetric 30°	5W
ESS1X3S-RGB		RGB	24V DC	IP68	1 LEDS 3W	R17/G30/B9lm	Symmetric 30°	6W
ESS1X3A-BF		6000°K	24V DC	IP68	1 LEDS 3W	68lm	Asymmetric 50-35°	5W
ESS1X3A-BC		3000°K	24V DC	IP68	1 LEDS 3W	62lm	Asymmetric 50-35°	5W
ESS1X3A-RGB		RGB	24V DC	IP68	1 LEDS 3W	R23/G33/B11lm	Asymmetric 50-35°	6W



EMPOTRABLE SUMERGIBLE 135mm WATERPROOF RECESSED 135mm



Empotrable sumergible de diámetro 135mm con haz de luz simétrico o asimétrico. Fabricado con cuerpo y embellecedor de acero 316. Cristal templado de 8mm. Incluye nicho empotrable para su instalación. Para el funcionamiento de los equipos RGB (4 cables) será preciso un controlador tipo PWM. Instalación ideal para piscinas, estanques...

Waterproof recessed 135mm diameter light beam is symmetrical or asymmetrical. Made with stainless steel section 316. 8mm tempered glass. Installation recessed enclosed. RGB (4-wire) control will require PWM driver. Ideal for pools, ponds...

Luminaria / Spotlight

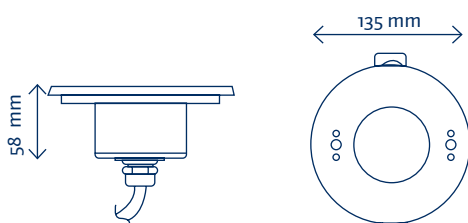

ESS3x3S-BF

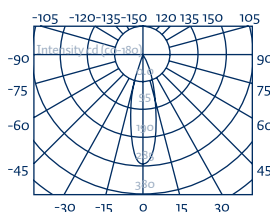

Nicho / Recessed

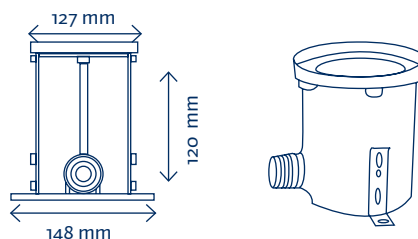

ESS3x3A-BF

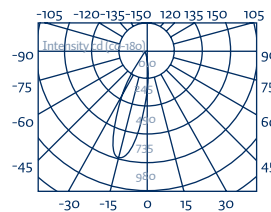

Instalación / Installation

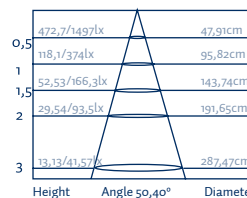
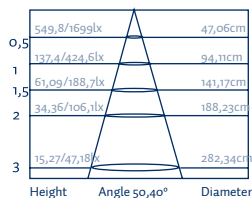
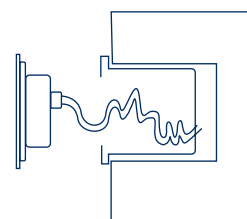

	COLOR COLOR	TEMP. TEMP.	ALIMENTACIÓN POWER SUPPLY	PROTECCIÓN PROTECTION	TIPO DE LED LED TYPE	FLUJO LUM. LUM. FLOW	ÁNGULO ANGLE	CONSUMO CONSUME
ESS3X3S-BF		6000°K	24V DC	IP68	4 LEDS 2W	310lm	Symmetric 30°	10W
ESS3X3S-BC		3000°K	24V DC	IP68	4 LEDS 2W	270lm	Symmetric 30°	10W
ESS3X3S-RGB		RGB	24V DC	IP68	4 LEDS 2W	R71/G108/B35	Symmetric 30°	12W
ESS3X3A-BF		6000°K	24V DC	IP68	4 LEDS 2W	330lm	Asymmetric 50-35°	10W
ESS3X3A-BC		3000°K	24V DC	IP68	4 LEDS 2W	290lm	Asymmetric 50-35°	10W
ESS3X3A-RGB		RGB	24V DC	IP68	4 LEDS 2W	R75/G116/B35	Asymmetric 50-35°	12W



EMPOTRABLE SUMERGIBLE 180mm WATERPROOF RECESSED 180mm



Empotrable sumergible de diámetro 180mm con haz de luz simétrico o asimétrico. Fabricado con cuerpo y embellecedor de acero 316. Cristal templado de 8mm. Incluye nicho empotrable para su instalación. Para el funcionamiento de los equipos RGB (4 cables) será preciso un controlador tipo PWM. Instalación ideal para piscinas, estanques...

Waterproof recessed 180mm diameter light beam is symmetrical or asymmetrical. Made with steel section 316. 8mm tempered glass. Installation recessed enclosed. RGB (4 wire) control will require PWM driver. Ideal for pools, ponds...

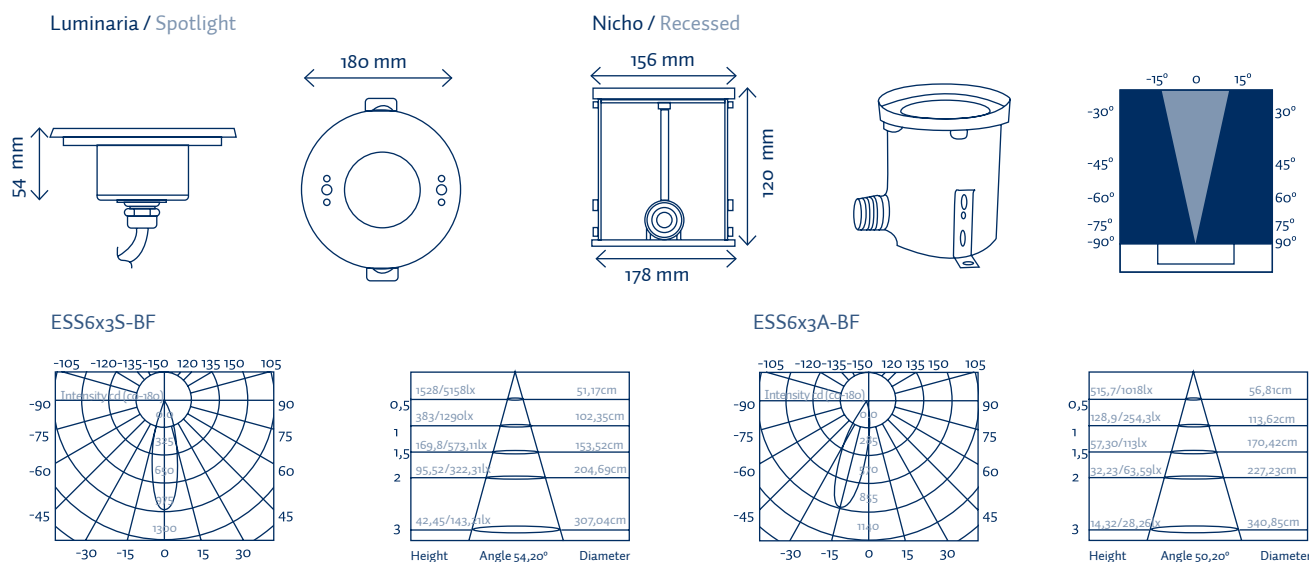

	COLOR COLOR	TEMP. TEMP.	ALIMENTACIÓN POWER SUPPLY	PROTECCIÓN PROTECTION	TIPO DE LED LED TYPE	FLUJO LUM. LUM. FLOW	ÁNGULO ANGLE	CONSUMO CONSUME
ESS6X3S-BF		6000°K	24V DC	IP68	6 LEDS 2W	545lm	Symmetric 30°	20W
ESS6X3S-BC		3000°K	24V DC	IP68	6 LEDS 2W	490lm	Symmetric 30°	20W
ESS6X3S-RGB		RGB	24V DC	IP68	6 LEDS 2W	R131/G255/	Symmetric 30°	25W
ESS6X3A-BF		6000°K	24V DC	IP68	6 LEDS 2W	B60	Asymmetric 50-35°	20W
ESS6X3A-BC		3000°K	24V DC	IP68	6 LEDS 2W	549lm	Asymmetric 50-35°	20W
ESS6X3A-RGB		RGB	24V DC	IP68	6 LEDS 2W	495lm	Asymmetric 50-35°	25W



EMPOTRABLE SUMERGIBLE RECTANGULAR RECTANGULAR WATERPROOF RECESSED



Empotrable sumergible rectangular con haz de luz simétrico o asimétrico. Fabricado con cuerpo y embellecedor de acero 316. Cristal templado de 8mm. Incluye nicho empotrable para su instalación. Para el funcionamiento de los equipos RGB (4 cables) será preciso un controlador tipo PWM. Instalación ideal para piscinas, estanques...

Rectangular waterproof recessed beam symmetrical or asymmetrical. Made with steel body 316. 8mm tempered glass. Installation recessed enclosed. RGB (4-wire) control will require PWM driver. Ideal for pools, ponds...

Luminaria / Spotlight

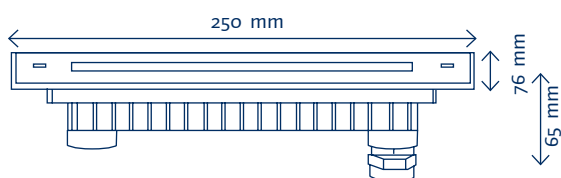

Nicho / Recessed

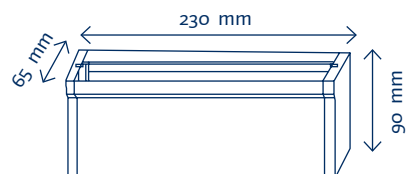

ESR6x2S-BC

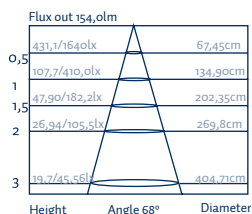
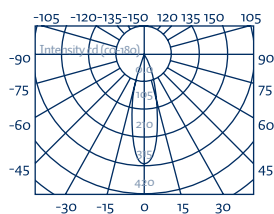

ESR6x2A-BF

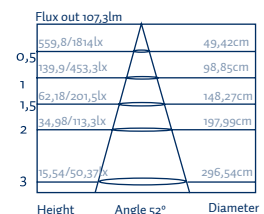
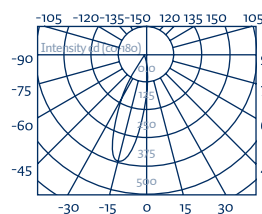

	COLOR COLOR	TEMP. TEMP.	ALIMENTACIÓN POWER SUPPLY	PROTECCIÓN PROTECTION	TIPO DE LED LED TYPE	FLUJO LUM. LUM. FLOW	ÁNGULO ANGLE	CONSUMO CONSUME
ESR6X2S-BF		6000°K	24V DC	IP68	6 LEDS 2W	605lm	Symmetric 30°	15W
ESR6X2S-BC		3000°K	24V DC	IP68	6 LEDS 2W	520lm	Symmetric 30°	15W
ESR6X2S-RGB		RGB	24V DC	IP68	6 LEDS 2W	R79/G166/B43	Symmetric 30°	20W
ESR6X2A-BF		6000°K	24V DC	IP68	6 LEDS 2W	610lm	Asymmetric 50-35°	15W
ESR6X2A-BC		3000°K	24V DC	IP68	6 LEDS 2W	525lm	Asymmetric 50-35°	15W
ESR6X2A-RGB		RGB	24V DC	IP68	6 LEDS 2W	R83/G170/B45	Asymmetric 50-35°	20W



PROYECTORES SUMERGIBLES WATERPROOF SPOTLIGHT



Proyector sumergible IP68 fabricado completamente en acero 316. Montado con óptica en ángulo de 15° para colores blancos y 25° para RGB. Para el funcionamiento de los equipos RGB será preciso un controlador tipo PWM.

IP68 stainless steel 316 waterproof spotlight. Mounted with optical angle of 15° to 25°, for white and RGB. RGB (4 wire) control will require PWM driver.

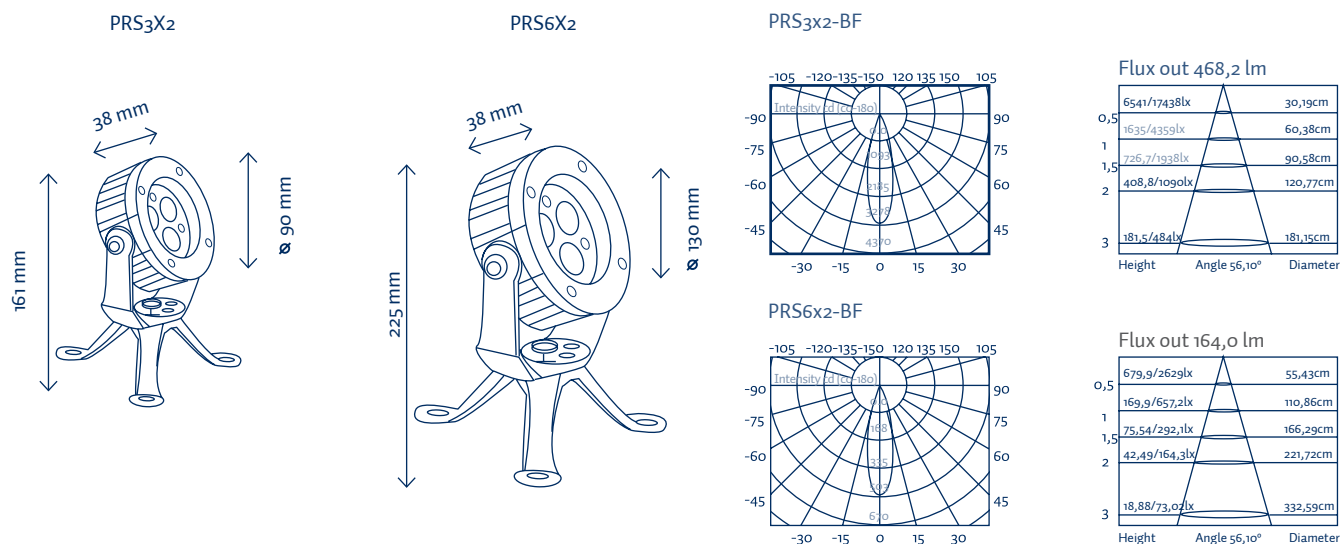

	COLOR COLOR	TEMP. TEMP.	ALIMENTACIÓN POWER SUPPLY	PROTECCIÓN PROTECTION	TIPO DE LED LED TYPE	FLUJO LUM. LUM. FLOW	ÁNGULO ANGLE	CONSUMO CONSUME
PRS3x2-BF		6000°K	24V DC	IP68	3 LEDS 2W	321lm	Symmetric 15°	8W
PRS3x2-BC		3000°K	24V DC	IP68	3 LEDS 2W	274lm	Symmetric 15°	8W
PRS3x2-RGB		RGB	24V DC	IP68	3 LEDS 2W	R48/G79/B20	Symmetric 25°	10W
PRS6x2-BF		6000°K	24V DC	IP68	6 LEDS 2W	600lm	Symmetric 15°	14W
PRS6x2-BC		3000°K	24V DC	IP68	6 LEDS 2W	520lm	Symmetric 15°	14W
PRS6x2-RGB		RGB	24V DC	IP68	6 LEDS 2W	R100/G155/B45	Symmetric 25°	16W



MINI PROYECTORES PARA PISCINA MINI SPOTLIGHT FOR SWIMMING POOL



Mini proyectores led en blanco o RGB para empotrar. Protección IP68. Cable incluido. Para controlar el mini proyector RGB es necesario el equipo de control RGBCONTROLLER16.

Mini recessed RGB or White LED spotlights. Protection IP68. Cable included. To control RGB spotlight is necessary a RGB-CONTROLLER16.

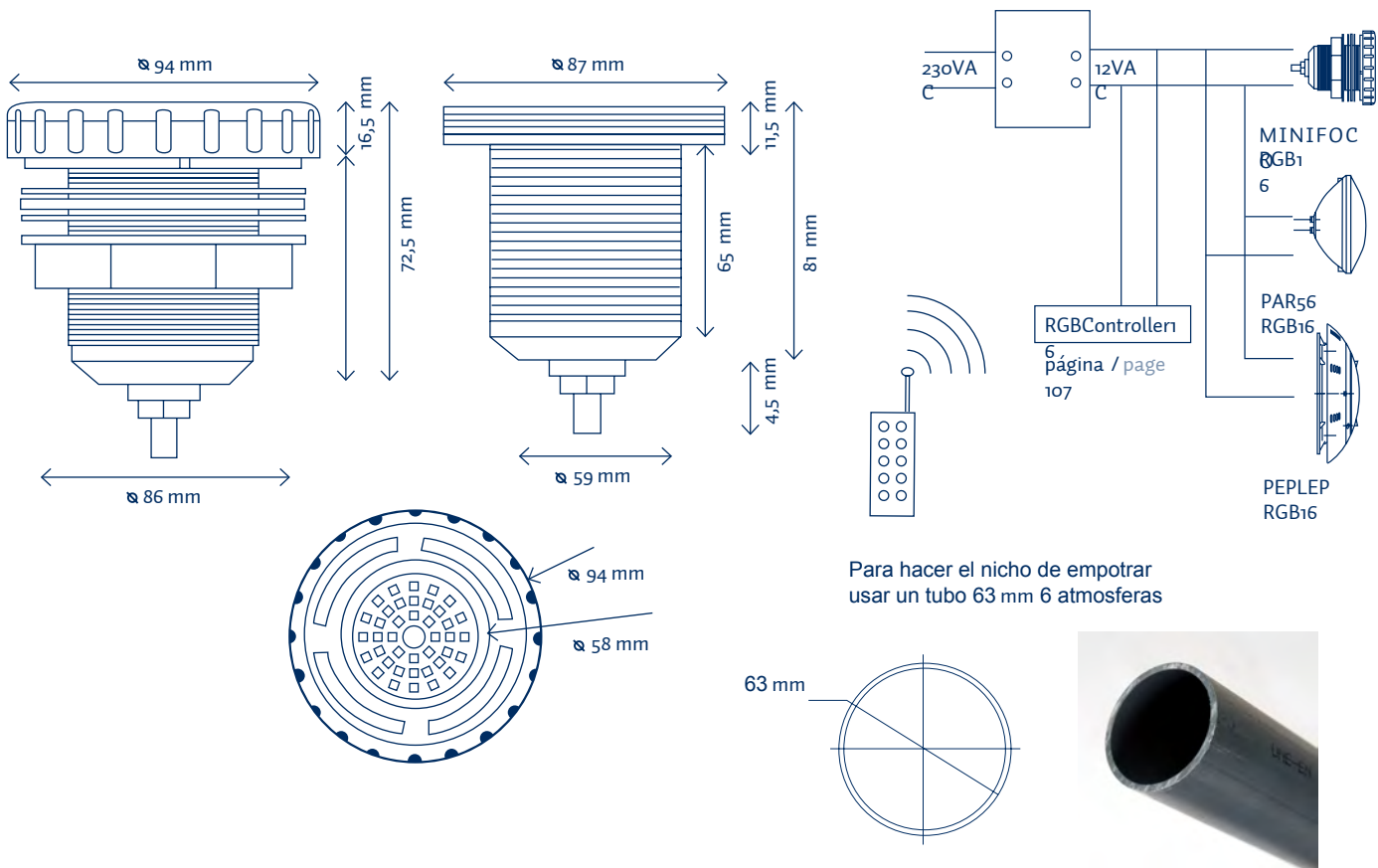

	COLOR COLOR	TIPO DE LED LED TYPE	ALIMENTACIÓN POWER SUPPLY	FLUJO LUM. LUM. FLOW	POTENCIA POWER	CONEXIÓN CONNECTION
FOMINIB		32 leds 3528	12VAC	54,7lm	5W	Cables/Wires
FOMINIRGB16		32 leds 3528	12VAC	24,25lm	5W	Cables/Wires

Controladores para mini proyectores en página 107 / Controls mini spotlight in page 107



BOMBILLA PAR56 PAR56 BULB



Bombillas en formato PAR56 de alta luminosidad y alta potencia. Se pueden sustituir directamente por las bombillas halógenas tradicionales.

PAR 56 bulbs with high brightness and power. They can be directly substituted for traditional halogen bulbs.



	COLOR COLOR	ALIMENTACIÓN POWER SUPPLY	LED LED	TIPO TYPE	CONTROL CONTROL	FLUJO LUM. LUM. FLOW	CONEXIÓN CONNECTION	CONSUMO CONSUME
PAR56B252LED		12V AC	252	3528	-	1200 lm	Tornillo/Screw	25W
RGB252LED		12V AC	252	3528	por pulsador / by pushbutton	1100 lm	Tornillo/Screw	25W
RGB252LED16		12V AC	252	3528	con controlador 16 / by controller 16	1200 lm	Tornillo/Screw	25W
HPAR56B		12V AC	18 x 3W	HP	-	1800 lm	Tornillo/Screw	36W
HPAR56RGB16		12V AC	18 x 3W	HP	con controlador 16 / by controller 16	1600 lm	Tornillo/Screw	36W

Controladores para bombillas en página 107 / Controls bulbs in page 107



ILUMINACIÓN EXTERIOR



12V/DC

BOMBILLA PAR56 CON 4 HILOS

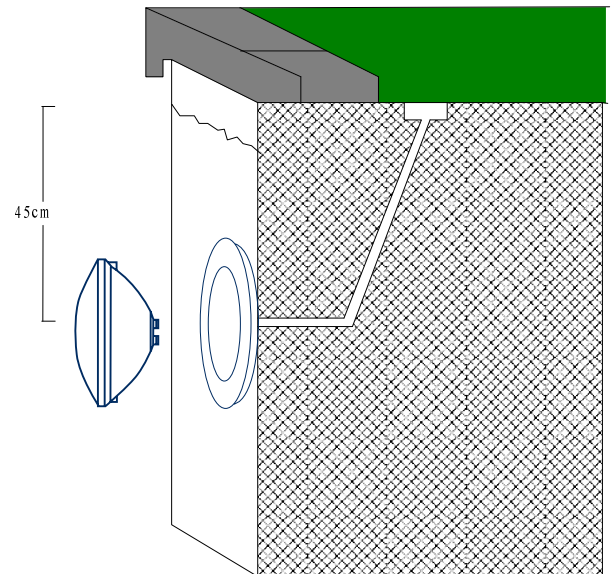
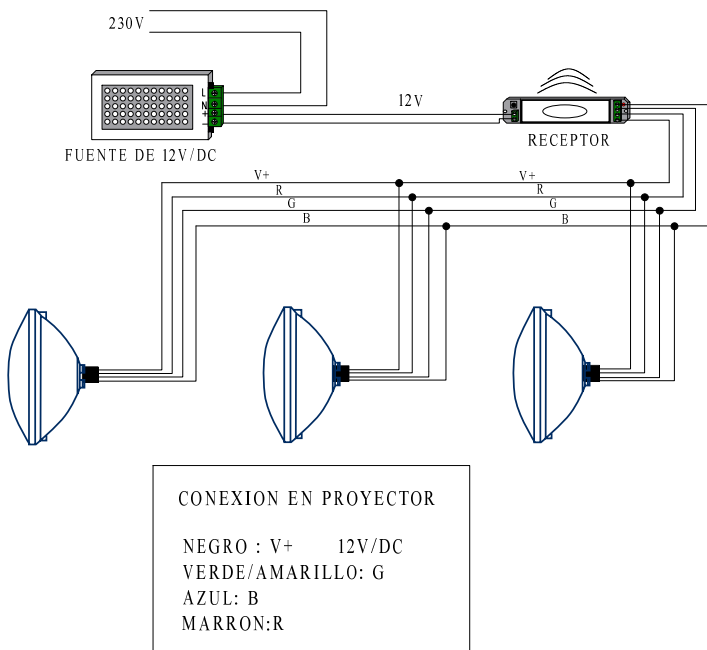
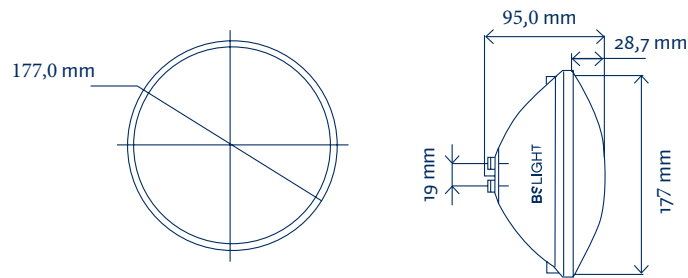

	COLOR COLOR	LED LED	TIPO TYPE	ALIMENTACIÓN POWER SUPPLY	CONTROL CONTROL	FLUJO LUM. LUM. FLOW	CONEXIÓN CONNECTION
RGB252LED4H		252	3528	12V DC	CONTROL RGB/MANDO	1200 lm	Cables / Wires

OUTDOOR LIGHTING

106
/
107



PROYECTORES PLANOS PARA PISCINA SWIMMING POOL FLAT SPOTLIGHTS



Proyectores planos para piscina de obra. Incluye todos los accesorios de instalación y funcionamiento.

Spotlights flat for pool. It includes all accessories installation and operation.

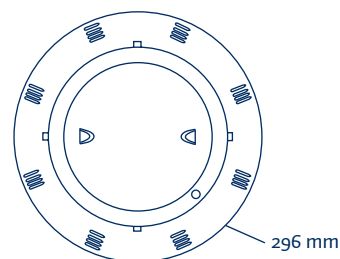
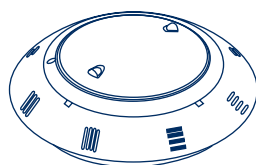
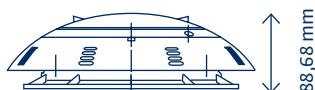

	COLOR COLOR	LED LED	ALIMENTACIÓN POWER SUPPLY	TIPO TYPE	CONTROL CONTROL	FLUJO LUM. LUM. FLOW	CONEXIÓN CONNECTION	CONSUMO CONSUME
PEPLED252RGB		252	12V AC	3528	por pulsador / by pushbutton	1100 lm	Cables / Wires	25W
PEPLED252RGB16		252	12V AC	3528	con controlador 16 / by controller 16	1100 lm	Cables / Wires	25W
PEPLED252B		252	12V AC	3528	-	1200 lm	Cables / Wires	25W
PEPLEDCONECT	Conjunto de racord trasero / Rear connector set							
INOXPEPLED	Aro embellecedor inox para proyectores planos / Stainless steel accessory for flat spotlights							

Controladores para proyectoros en página 107 / controls spotlight in page 107



ILUMINACIÓN EXTERIOR



12V/DC

PROYECTOR PLANO PARA PISCINA RGB 4 HILOS

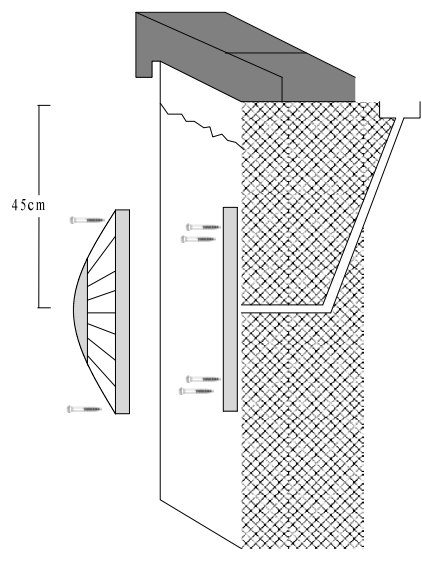
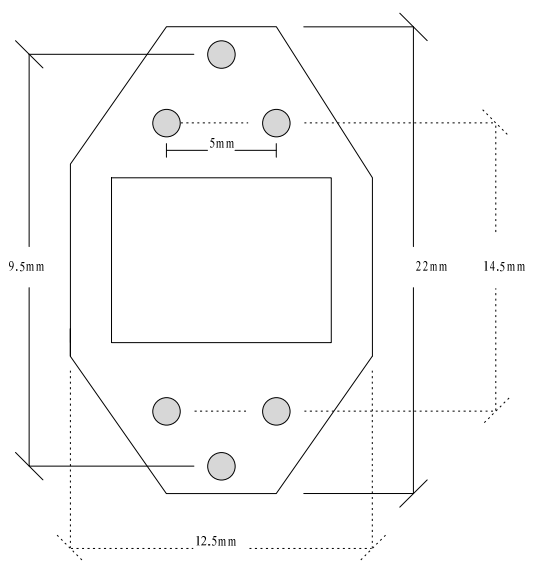
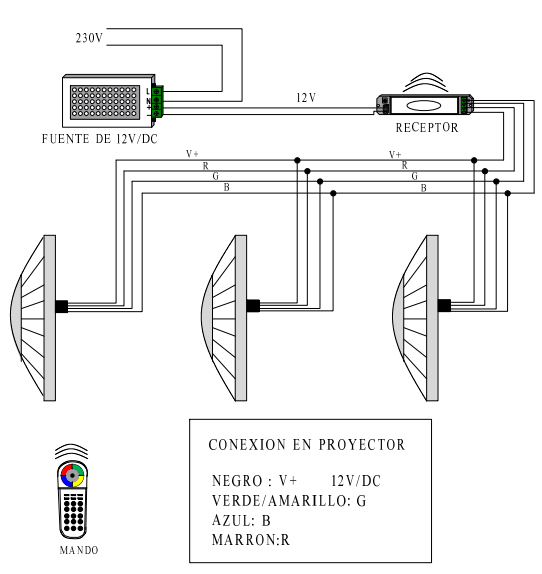
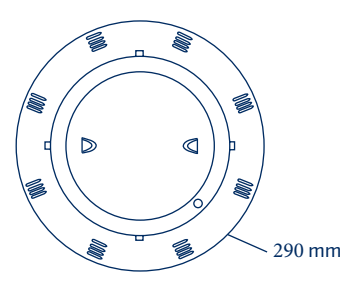
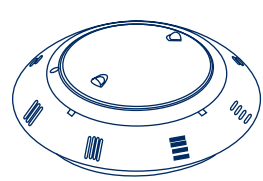
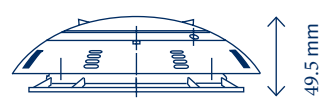

	COLOR COLOR	LED LED	TIPO TYPE	ALIMENTACIÓN POWER SUPPLY	CONTROL CONTROL	FLUJO LUM. LUM. FLOW	CONEXIÓN CONNECTION
PEPLEDRGB-4H		252	3528	12V DC	CONTROL RGB/MANDO RGB	1100 lm	Cables / Wires

OUTDOOR LIGHTING



CONTROLADOR RGB PARA PAR56 Y PROYECTORES RGB CONTROLLER FOR PAR56 AND SPOTLIGHTS



Controlador RGB para bombillas PAR56 para los modelos RGB252LED16, HPAR56RGB16, proyectores PEPLD252RGB16 y mini proyectores FOMINIRGB16.

RGB controller for PAR56 bulbs RGB252LED16, HPAR56RGB16, spotlights model PEPLD252RGB16 and mini spotlight FOMINIRGB16.

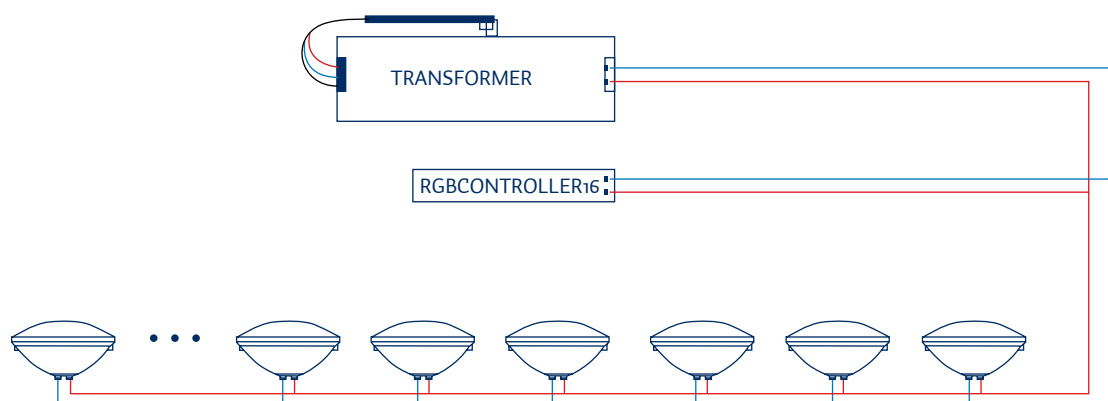

	DESCRIPCIÓN DESCRIPTION	CONSUMO CONSUME	TENSIÓN VOLTAGE	CANT. MÁX. BOMBILLAS NUMBER OF BULBS	LARGO MÁX. CABLE MAXIMUM WIRE
RGBCONTROLLER16	controlador 16 / controller 16	8 W	12V AC	20	100 m
AMPCONTROLLER	amplificador / amplifier	8 W	12V AC	20	100 m



SEÑALIZACIÓN INDUSTRIAL

05

INDUSTRIAL
SIGNALLING



BOMBILLAS BA9s MULTILED BA9s MULTILED BULBS



Bombillas BA9s multiled para su inserción en cualquier casquillo BA9s.

BA9s multiled bulbs to be placed in any BA9s socket.

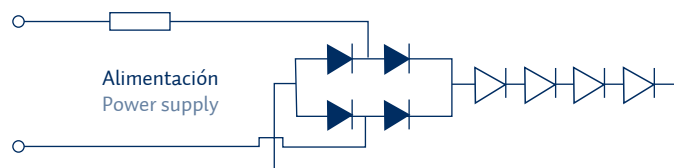
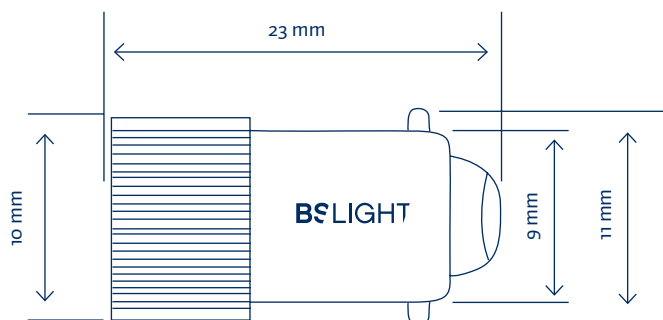

	COLOR COLOR	ALIMENTACIÓN POWER SUPPLY	LUMINOSIDAD BRIGHTNESS
BA9SLED24R	■	24V AC/DC	2000cd/m2
BA9SLED24V	■	24V AC/DC	1500cd/m2
BA9SLED24B	■	24V AC/DC	2450cd/m2
BA9SLED24A	■	24V AC/DC	2700cd/m2
BA9SLED24AZ	■	24V AC/DC	850cd/m2
BA9SLED48R	■	48V AC	2000cd/m2
BA9SLED48V	■	48V AC	1500cd/m2
BA9SLED48B	■	48V AC	2450cd/m2
BA9SLED48A	■	48V AC	2700cd/m2
BA9SLED48AZ	■	48V AC	850cd/m2

	COLOR COLOR	ALIMENTACIÓN POWER SUPPLY	LUMINOSIDAD BRIGHTNESS
BA9SLED110R	■	110V AC	600cd/m2
BA9SLED110V	■	110V AC	900cd/m2
BA9SLED110B	■	110V AC	2300cd/m2
BA9SLED110A	■	110V AC	950cd/m2
BA9SLED110AZ	■	110V AC	500cd/m2
BA9SLED220R	■	230V AC	460cd/m2
BA9SLED220V	■	230V AC	850cd/m2
BA9SLED220B	■	230V AC	1200cd/m2
BA9SLED220A	■	230V AC	550cd/m2
BA9SLED220AZ	■	230V AC	330cd/m2



PILOTO 5MM 5MM PILOT



Piloto 5 mm con mirilla cromo y cable de alimentación.
Mirillas en cromo, blanco o negro.

5 mm Pilot with sight hole and power supply wire.
Sight hole in chrome, white or black.

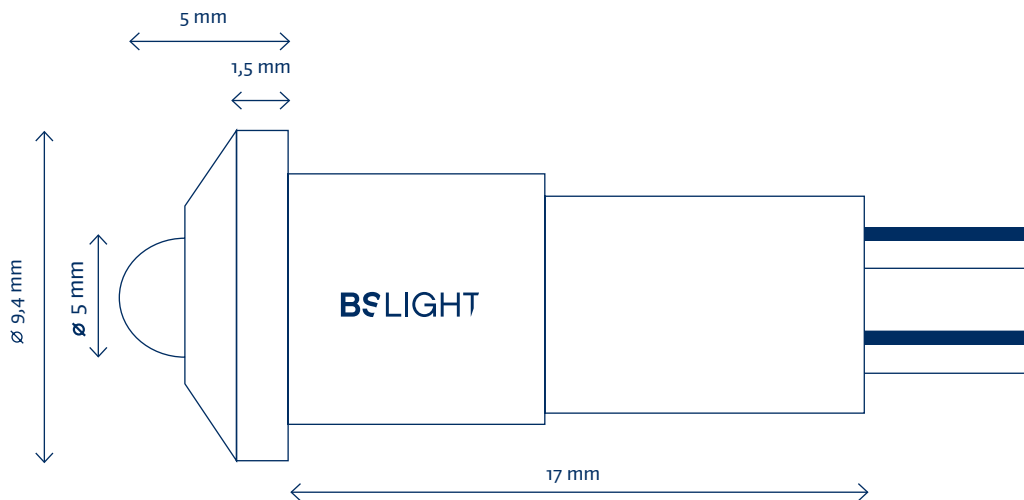

	COLOR	TIPO DE LED / LED TYPE	ALIMENTACIÓN / POWER SUPPLY	DIÁMETRO / DIAMETER	CABLE / WIRE
L26012BPC		5mm 16.000mcd	12V DC	8mm	40cm
L260230BPC		5mm 16.000mcd	230V AC	8mm	40cm
L26012BPC-60		5mm 16.000mcd	12V DC	8mm	60cm
L260230BPC-60		5mm 16.000mcd	230V AC	8mm	60cm
L26012BPC-230		5mm 16.000mcd	12V DC	8mm	230cm
L260230BPC-230		5mm 16.000mcd	230V AC	8mm	230cm



PILOTOS 22MM MULTILED MULTILED 22MM PILOTS



Piloto multiled en plástico para su colocación en taladros estándar de 22 mm.

Plastic multiled pilots to be placed in standard 22 mm drills.

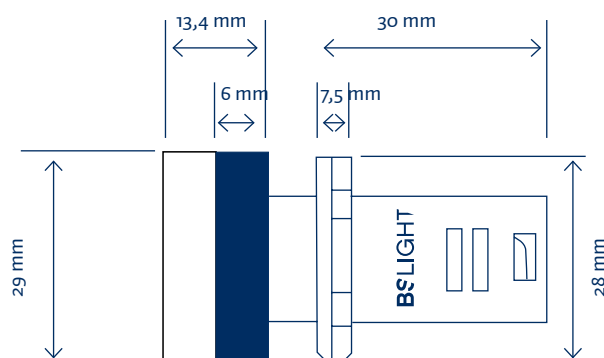

	COLOR COLOR	ALIMENTACIÓN POWER SUPPLY		COLOR COLOR	ALIMENTACIÓN POWER SUPPLY
HD16-22D/S-AZ-12	■	12V AC/DC	HD16-22D/S-R-48	■	48V AC
HD16-22D/S-A-12	■	12V AC/DC	HD16-22D/S-V-48	■	48V AC
HD16-22D/S-B-12	□	12V AC/DC	HD16-22D/S-AZ-110	■	110V AC
HD16-22D/S-R-12	■	12V AC/DC	HD16-22D/S-A-110	■	110V AC
HD16-22D/S-V-12	■	12V AC/DC	HD16-22D/S-B-110	□	110V AC
HD16-22D/S-R-24	■	24V AC/DC	HD16-22D/S-R-110	■	110V AC
HD16-22D/S-V-24	■	24V AC/DC	HD16-22D/S-V-110	■	110V AC
HD16-22D/S-B-24	□	24V AC/DC	HD16-22D/S-R-230	■	230V AC
HD16-22D/S-AZ-24	■	24V AC/DC	HD16-22D/S-V-230	■	230V AC
HD16-22D/S-A-24	■	24V AC/DC	HD16-22D/S-B-230	□	230V AC
HD16-22D/S-AZ-48	■	48V AC	HD16-22D/S-AZ-230	■	230V AC
HD16-22D/S-A-48	■	48V AC	HD16-22D/S-A-230	■	230V AC
HD16-22D/S-B-48	□	48V AC			



BALIZA MULTILED 22MM MULTILED BEACON 22MM



Balizas multiled con rosca 22mm para señalización. Se fabrica en mono color fijo, intermitente, con zumbador y RGB configurable.

Multiled Beacon with thread 22mm to signal. It's making fix color, intermittent, with buzzer and configurable RGB.

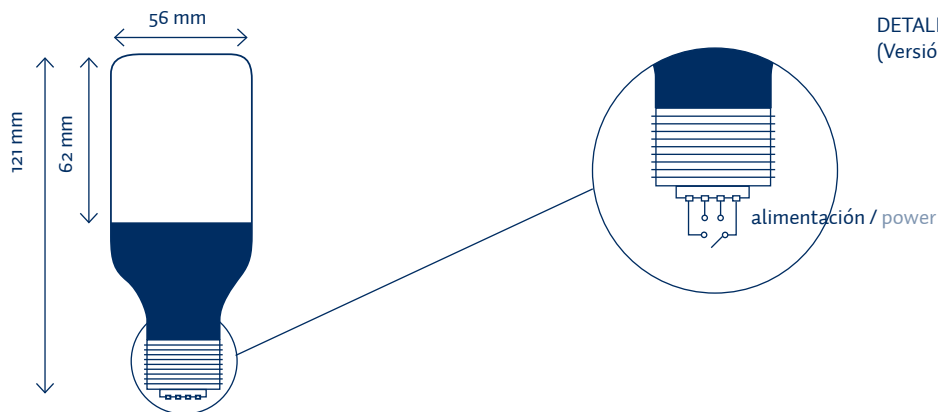

DETALLE DE CONEXIONADO
(Versión con zumbador)

	COLOR COLOR	TIPO TYPE	ALIMENTACIÓN POWER SUPPLY	FIJACIÓN FIXING
L810-xx-xx		Fija / Fix	12VAC/DC 24VAC/DC 110VAC 230VAC	Rosca / Thread 22mm
L810-xx-xx-BZ		Fija + zumbador / Fix + buzzer		Rosca / Thread 22mm
L811-xx-xx		Intermitente / Intermittent		Rosca / Thread 22mm
L811-xx-xx-BZ		Inter. + zumbador / Intermittent + buzzer		Rosca / Thread 22mm
L812-xx-xx		Rotativa / Rotary		Rosca / Thread 22mm
L812-xx-xx-BZ		Rot. + zumbador / Rotary + buzzer		Rosca / Thread 22mm
L813-xx-xx	RGB	Fija e intermitente / Fix and intermittent		Rosca / Thread 22mm
L813-xx-xx-BZ	RGB	Fija e inter. + zum. / Fix and intermittend + buzzer		Rosca / Thread 22mm

ACCESORIOS / ACCESSORIES

80010	Soporte pié 70mm / Floor stand
80015	Fijación mural para soporte / Mural fixing to floor stand
80020	Tubo aluminio 70mm / Aluminum tube



ILUMINACIÓN INDUSTRIAL

06

INDUSTRIAL LIGHTING



CAMPANAS INDUSTRIALES HASTA 100W LED HIGH BAY LIGHT UNTIL 100W



Campanas Industriales de 80 y 100W para la sustitución directa de las tradicionales campanas de mercurio alta presión o de sodio mejorando el rendimiento y obteniendo unos grandes ahorros energéticos. Montado con LEDs Philips Lumileds Luxeon y con driver de la marca Meanwell. Se ofrecen diferentes alternativas en temperatura de color y ángulos de iluminación.

High bay light 80 and 100w to be replaced the traditional high-pressure mercury or sodium lamps. Improved the energy efficiency and get energy saving. LED Philips Lumileds Luxeon assembled with Meanwell drivers. You can choose from several options like color temperature and light angle.

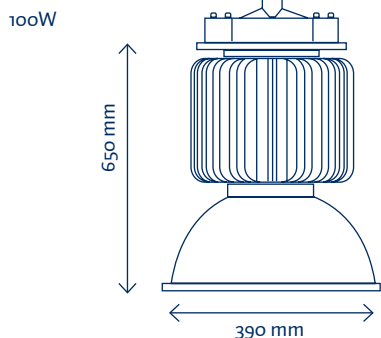
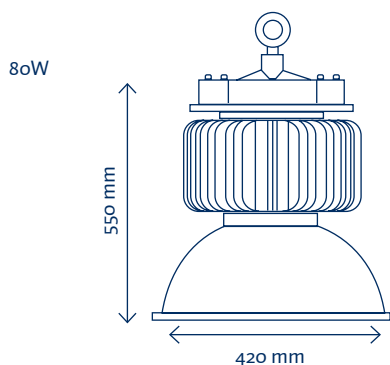

COMPARATIVA
COMPARATIVE
COB80w = 150W MH
COB100w = 200W MH

C-80W

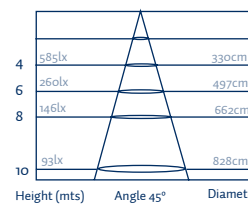
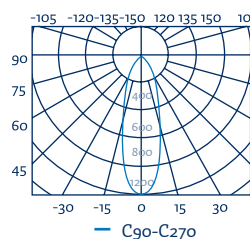

C-100W

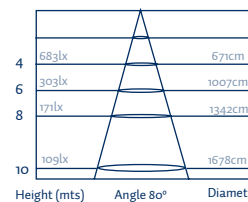
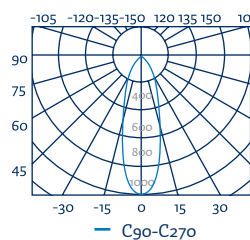

	TEMP. TEMP.	ÁNGULO ANGLE	ALIMENTACIÓN POWER SUPPLY	MEDIDAS MEASURE	TIPO DE LED LED TYPE	FLUJO LUM. LUM. FLOW	CONSUMO CONSUME
C-80W-XX-XX	4000° - 7000°	45°/80°/100°	90-260V AC	Ø420x550mm	Philips 80W	7000lm	95W
C-100W-XX-XX	4000° - 7000°	80°/100°	90-260V AC	Ø390x650mm	Philips 100W	9000lm	110W



CAMPANAS INDUSTRIALES HASTA 200W LED HIGH BAY LIGHT UNTIL 200W



Campanas Industriales de 150 y 200W para la sustitución directa de las tradicionales campanas de mercurio alta presión o de sodio mejorando el rendimiento y obteniendo unos grandes ahorros energéticos. Montado con LEDs Philips Lumileds Luxeon y con driver de la marca Meanwell. Se ofrecen diferentes alternativas en temperatura de color y ángulos de iluminación.

High bay light of 150 and 200w to replace the traditional high-pressure mercury or sodium lamps. Improved the energy efficiency and get energy saving. LED Philips Lumileds Luxeon assembled with Meanwell drivers. You can choose from several options like color temperature and illumination angle.

150W

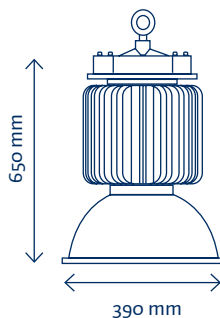

C-150W

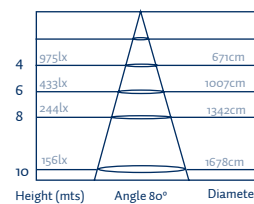
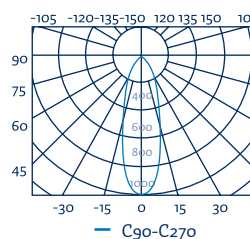

200W

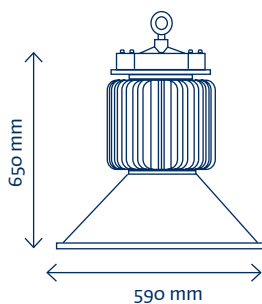

C-200W

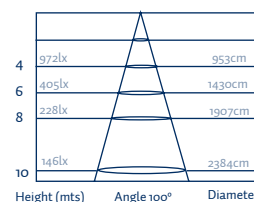
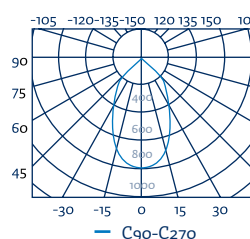

COMPARATIVA
COMPARATIVE
COB_{150W} = 250W MH
COB_{200W} = 400W MH

	TEMP. TEMP.	ÁNGULO ANGLE	ALIMENTACIÓN POWER SUPPLY	MEDIDAS MEASURE	TIPO DE LED LED TYPE	FLUJO LUM. LUM. FLOW	CONSUMO CONSUME
C-150W-XX-XX	4000° - 7000°	80°/100°	90-260V AC	Ø390x650mm	Philips 150W	13000lm	170W
C-200W-XX-XX	4000° - 7000°	80°/100°	90-260V AC	Ø590x650mm	Philips 200W	18000lm	220W



PROYECTORES HASTA 50W FLOOD LIGHT UNTIL 50W



Proyectores en carcasa de aluminio con protección IP65 de 10W a 50W ideales para iluminación de fachadas y edificios. Incorpora LED tipo COB con alimentador interno para funcionamiento a 230V AC.

IP65 Aluminum housing spotlights from 10w to 50W, destined for outdoors and building illumination. COB LED and internal supply to work 230V AC.

PR10WCOB

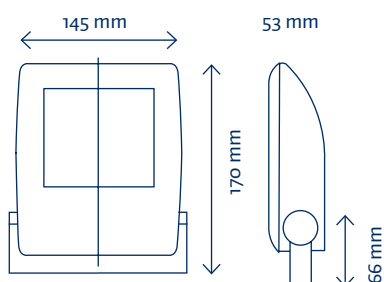

PR30WCOB

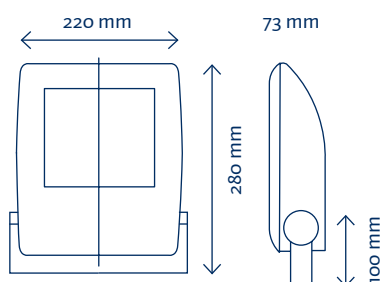

PR50WCOB

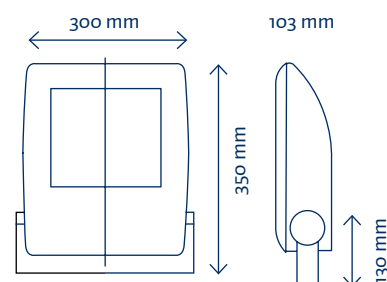

	TEMP. TEMP.	ÁNGULO ANGLE	ALIMENTACIÓN POWER SUPPLY	MEDIDAS MEASURE	TIPO DE LED LED TYPE	FLUJO LUM. LUM. FLOW	CONSUMO CONSUME
PR10WCOB	2700-7000°K	120°	220-240V AC	170x145x53mm	1 COB 10W	800lm (6000K)	15W
PR30WCOB	2700-7000°K	120°	220-240V AC	280x220x73mm	1 COB 30W	2400lm (6000K)	35W
PR50WCOB	2700-7000°K	120°	220-240V AC	350x300x103mm	1 COB 50W	4000lm (6000K)	55W



PROYECTORES HASTA 200W FLOOD LIGHT UNTIL 200W



Proyector en carcasa de aluminio con protección IP65 de 100W a 200W ideales para iluminación de fachadas y edificios. Incorpora led tipo COB con alimentador interno para funcionamiento a 230VAC.

IP65 Aluminum housing spotlights from 100W to 200W, destined to outdoors and buildings illumination. COB LED and internal supply to work 230VAC .

PR100WCOB
PR150WCOB

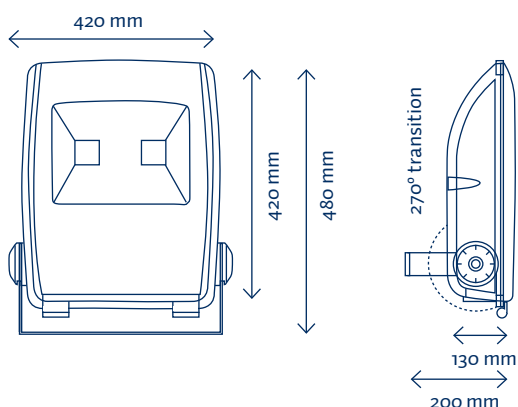

PR200WCOB

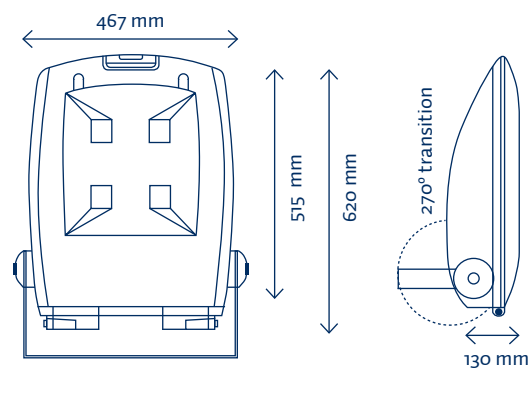

	TEMP. TEMP.	ÁNGULO ANGLE	ALIMENTACIÓN POWER SUPPLY	MEDIDAS MEASURE	TIPO DE LED LED TYPE	FLUJO LUM. LUM. FLOW	CONSUMO CONSUME
PR100WCOB	2700-7000°K	120°	220-240VAC	420X420X130mm	2 COB 50W	7700lm (6000K)	110W
PR150WCOB	2700-7000°K	120°	220-240VAC	420X420X130mm	4 COB 40W	14400lm (6000K)	160W
PR200WCOB	2700-7000°K	120°	220-240VAC	515X467X150mm	4 COB 50W	18000lm (6000K)	210W

120
/
121



LUMINARIA URBANA 56W STREET LIGHT 56W



Luminaria para uso urbano con 56 LEDS HP. Carcasa de aluminio de alta resistencia con grado de protección IP65. Ideales para iluminación de vías residenciales en báculos de baja altura. Fácil instalación, se adaptan a báculos estándar de tubo 60mm.

Street light with 56 LEDS HP. Aluminum housing with high strength IP65. Ideal for lighting residential streets in low-rise staffs. Easy Installation, adapt to standard staff of pipe 60mm.

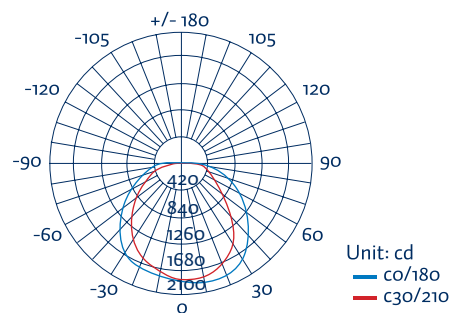
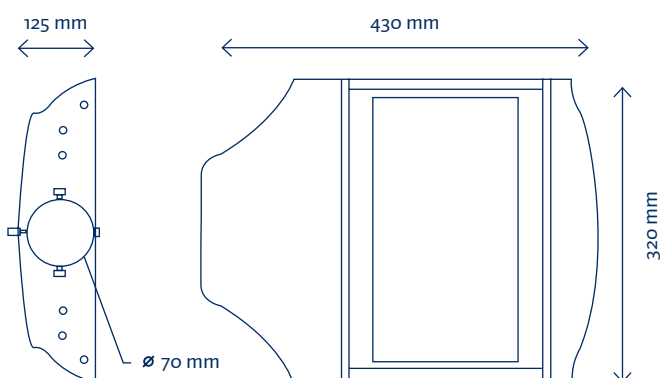

H m	lx
2,5	322,59
5,0	80,65
7,5	35,84
10	20,16
10	12,90

■ Co-C180
■ C90-C270

	COLOR COLOR	TEMP. TEMP.	PROTECCIÓN PROTECTION	ALIMENTACIÓN POWER SUPPLY	ÁNGULO ANGLE	TIPO DE LED LED TYPE	FLUJO LUM. LUM. FLOW	CONSUMO CONSUME
FU-56W-BF	□	6000°K	IP65	85-264V AC	120°	56 LED 1W HP	5443lm	65W



LUMINARIA URBANA 98W STREET LIGHT 98W



Luminaria para uso urbano con 98 LEDS HP. Carcasa de aluminio de alta resistencia con grado de protección IP65. Ideales para iluminación de vías residenciales en báculos de media altura. Fácil instalación, se adaptan a báculos estándar de tubo 60mm.

Street light with 98 LEDS HP. Aluminum housing with high strength IP65. Ideal for lighting residential streets in half-height staffs. Easy Installation, adapt to standard staff of pipe 60mm.

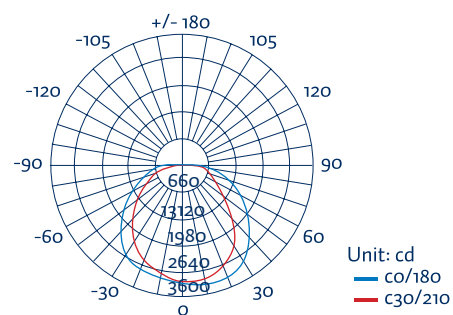
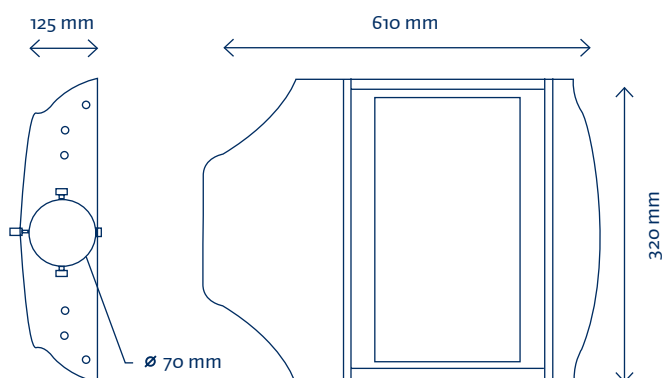

H m	lx
2,5	568,10
5,0	141,45
7,5	63,25
10	33,56
10	22,88

■ Co-C180
 ■ C90-C270

	COLOR COLOR	TEMP. TEMP.	PROTECCIÓN PROTECTION	ALIMENTACIÓN POWER SUPPLY	ÁNGULO ANGLE	TIPO DE LED LED TYPE	FLUJO LUM. LUM. FLOW	CONSUMO CONSUME
FU-98W-BF	□	6000°K	IP65	85-264V AC	120°	98 LED 1W HP	10.165lm	110W

122
/
123



LUMINARIA URBANA 126W STREET LIGHT 126W



Luminaria para uso urbano con 126 LEDS HP. Carcasa de aluminio de alta resistencia con grado de protección IP65. Ideales para iluminación de vías residenciales en báculos de baja altura. Fácil instalación, se adaptan a báculos estándar de tubo 60mm.

Street light with 126 LEDS HP. Aluminum housing with high strength IP65. Ideal for lighting residential streets in low-rise staffs. Easy Installation, adapt to standard staff of pipe 60mm.

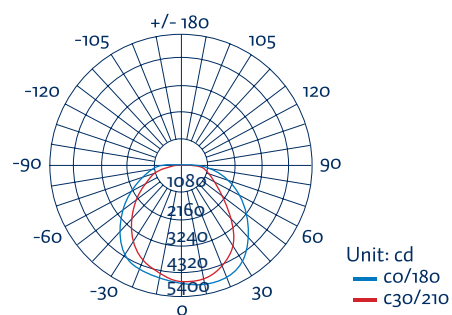
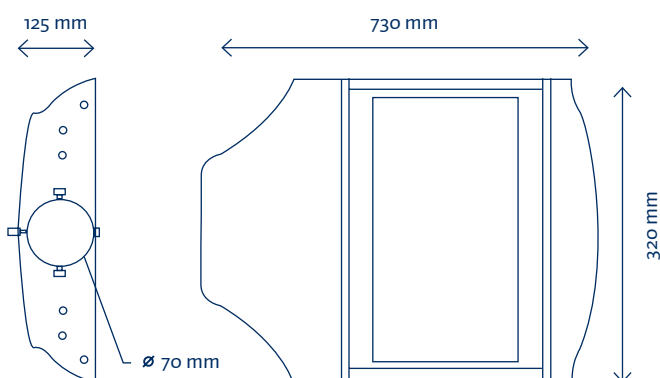

H m	lx
2,5	776,28
5,0	194,36
7,5	86,35
10	48,56
10	31,08

■ Co-C180
■ C90-C270

	COLOR COLOR	TEMP. TEMP.	PROTECCIÓN PROTECTION	ALIMENTACIÓN POWER SUPPLY	ÁNGULO ANGLE	TIPO DE LED LED TYPE	FLUJO LUM. LUM. FLOW	CONSUMO CONSUME
FU-126W-BF	□	6000°K	IP65	85-264V AC	120°	126 LED 1W HP	13300lm	140W

“BSLIGHT un mundo
de soluciones para su
iluminación”

“BSLIGHT
a world lighting solution”

BSV.
with you since 1984

C/ Ribera del Congost, 40 · Pol.Ind. Sector V
08520 Les Franqueses del Vallès · Barcelona · Spain
Tel. (+34) 93 861 51 15 · **Fax** (+34) 93 861 52 99 · bsv@bsvelectronic.com
[www. bsvelectronic.com](http://www.bsvelectronic.com)